

TEG-S2500i
24+2G Stackable
Switch

User's Guide

Version 11.01

4/26/2004

TRENDware

TRENDnet

Limited Warranty

TRENDware warrants its products against defects in material and workmanship, under normal use and service, for the following lengths of time from the date of purchase.

Wired 10/100/1000Mbps Ethernet Products (Adapter, Switch, Router, Firewall, VPN, Fiber)	5 years*
*AC adapter, Cooling Fan, and Power Supply	1 year

If a product does not operate as warranted above during the applicable warranty period, TRENDware shall, at its option and expense, repair the defective product or part, deliver to customer an equivalent product or part to replace the defective item, or refund to customer the purchase price paid for the defective product. All products that are replaced will become the property of TRENDware. Replacement products may be new or reconditioned.

TRENDware shall not be responsible for any software, firmware, information, or memory data of customer contained in, stored on, or integrated with any products returned to TRENDware pursuant to any warranty.

There are no user serviceable parts inside the product. Do not remove or attempt to service the product by any unauthorized service center. This warranty is voided if (i) the product has been modified or repaired by any unauthorized service center, (ii) the product was subject to accident, abuse, or improper use (iii) the product was subject to conditions more severe than those specified in the manual.

Warranty service may be obtained by contacting TRENDware office within the applicable warranty period for a Return Material Authorization (RMA) number, accompanied by a copy of the dated proof of the purchase. Products returned to TRENDware must be pre-authorized by TRENDware with RMA number marked on the outside of the package, and sent prepaid, insured and packaged appropriately for safe shipment.

WARRANTIES EXCLUSIVE: IF THE TRENDWARE PRODUCT DOES NOT OPERATE AS WARRANTED ABOVE, THE CUSTOMER'S SOLE REMEDY SHALL BE, AT TRENDWARE'S OPTION, REPAIR OR REPLACEMENT. THE FOREGOING WARRANTIES AND REMEDIES ARE EXCLUSIVE AND ARE IN LIEU OF ALL OTHER WARRANTIES, EXPRESSED OR IMPLIED, EITHER IN FACT OR BY OPERATION OF LAW, STATUTORY OR OTHERWISE, INCLUDING WARRANTIES OF MERCHANTABILITY AND FITNESS FOR A PARTICULAR PURPOSE. TRENDWARE NEITHER ASSUMES NOR AUTHORIZES ANY OTHER PERSON TO ASSUME FOR IT ANY OTHER LIABILITY IN CONNECTION WITH THE SALE, INSTALLATION MAINTENANCE OR USE OF TRENDWARE'S PRODUCTS.

TRENDWARE SHALL NOT BE LIABLE UNDER THIS WARRANTY IF ITS TESTING AND EXAMINATION DISCLOSE THAT THE ALLEGED DEFECT IN THE PRODUCT DOES NOT EXIST OR WAS CAUSED BY CUSTOMER'S OR ANY THIRD PERSON'S MISUSE, NEGLIGENCE, IMPROPER INSTALLATION OR TESTING, UNAUTHORIZED ATTEMPTS TO REPAIR OR MODIFY, OR ANY OTHER CAUSE BEYOND THE RANGE OF THE INTENDED USE, OR BY ACCIDENT, FIRE, LIGHTNING, OR OTHER HAZARD.

LIMITATION OF LIABILITY: TO THE FULL EXTENT ALLOWED BY LAW TRENDWARE ALSO EXCLUDES FOR ITSELF AND ITS SUPPLIERS ANY LIABILITY, WHETHER BASED IN CONTRACT OR TORT (INCLUDING NEGLIGENCE), FOR INCIDENTAL, CONSEQUENTIAL, INDIRECT, SPECIAL, OR PUNITIVE DAMAGES OF ANY KIND, OR FOR LOSS OF REVENUE OR PROFITS, LOSS OF BUSINESS, LOSS OF INFORMATION OR DATA, OR OTHER FINANCIAL LOSS ARISING OUT OF OR IN CONNECTION WITH THE SALE, INSTALLATION, MAINTENANCE, USE, PERFORMANCE, FAILURE, OR INTERRUPTION OF THE POSSIBILITY OF SUCH DAMAGES, AND LIMITS ITS LIABILITY TO REPAIR, REPLACEMENT, OR REFUND OF THE PURCHASE PRICE PAID, AT TRENDWARE'S OPTION. THIS DISCLAIMER OF LIABILITY FOR DAMAGES WILL NOT BE AFFECTED IF ANY REMEDY PROVIDED HEREIN SHALL FAIL OF ITS ESSENTIAL PURPOSE.

Governing Law: This Limited Warranty shall be governed by the laws of the state of California.

TRENDware International Inc.
3135 Kashiwa Street
Torrance, CA 90505
USA
Tel: (310) 891-1100
www.trendnet.com

TEG-S2500i Stackable Switch User's Guide

1. INTRODUCTION	7
1.2 INSTALLATION	8
1.3 INITIAL SET UP FOR MANAGEMENT	10
1.3.1 out-of-band Terminal-mode Management	10
1.3.2 In-band management through Ethernet	11
1.3.3 Telnet management	13
1.4 LED INDICATORS INFORMATION	14
2. WEB MANAGEMENT FUNCTION	15
2.1. WEB MANAGEMENT HOME OVERVIEW	15
2.2. PORT STATUS	16
2.2.1 single port counter and status	17
2.3. PORT STATISTICS	18
2.4. SHOW MAC TABLE	19
2.5. ADMINISTRATOR	20
2.5.1. IP and Management mode	20
2.5.2 Switch Setting	22
2.5.2.1 Advanced	22
2.5.2.2 Misc Config	23
2.5.3 Console Port Information	24
2.5.4 Port Controls	25
2.5.5 Trunking	27
2.5.5.1 Aggregator setting	27
2.5.5.2 Aggregator Information	28
2.5.5.3 State Activity	29
2.5.6 Filter Database	30
2.5.6.1. IGMP Snooping	30
2.5.6.2. Static MAC Address	31
2.5.6.3 MAC filtering	32
2.5.7. VLAN configuration	33
2.5.7.1. Port Based VLAN	35
2.5.7.2. 802.1Q VLAN	36
2.5.8. Spanning Tree	40
2.5.9. Port Mirror	42
2.5.10. SNMP/Trap Manager	43
2.5.11 Security Manager	45
2.5.12 802.1x Configuration	46
2.5.13 Ping	48

2.5.14 Agent /Stacking Management	49
2.5.14.1 Management Web UI	50
2.5.14.2 Agent Manager	52
2.5.14.3 Stacking Manager	53
2.6. TFTP UPDATE FIRMWARE	58
2.7. CONFIGURATION BACKUP	59
2.7.1. TFTP Restore Configuration	59
2.7.2. TFTP Backup Configuration	59
2.8. RESET SYSTEM	60
2.9. REBOOT	60
2.10. EVENT LOGGING	61
3. CONSOLE -- 1K XMODEM UPDATE FIRMWARE.....	62
4. OUT-OF-BAND TERMINAL MODE MANAGEMENT.....	65
4.1 MAIN MENU.....	66
4.2 SWITCH STATIC CONFIGURATION.....	67
4.2.1. Port Configuration	68
4.2.2. Trunk Configuration	70
4.2.3. VLAN Configuration.....	71
4.2.3.1. VLAN Configure	71
4.2.3.2. Create a VLAN Group	73
4.2.3.3. Edit / Delete a VLAN Group.....	75
4.2.3.4. Groups Sorted Mode	76
4.2.4. Misc Configuration	77
4.2.4.1. Ping	78
4.2.4.2. MAC Age Interval.....	78
4.2.4.3. Broadcast Storm Filtering	79
4.2.4.4. Max bridge transmit delay bound.....	80
4.2.4.5. Port Security	80
4.2.4.5. Collisions Retry Forever	81
4.2.4.6. Hash Algorithm	82
4.2.4.7. IFG Compensation	82
4.2.5. Administration Configuration	84
4.2.5.1. Change Username	84
4.2.5.2. Change Password	85
4.2.5.3. Device Information	85
4.2.5.4. IP Configuration.....	86
4.2.6. Port Mirror Configuration	87
4.2.7. Priority Configuration.....	88

4.2.7.1. Port Static Priority.....	88
4.2.7.2. 802.1p Priority Configuration	89
4.2.8. MAC Address Configuration	90
4.2.8.1. Static MAC Address.....	90
4.2.8.2. Filtering MAC Address	94
4.3. PROTOCOL RELATED CONFIGURATION.....	98
4.3.1. STP.....	98
4.3.1.1. Enable/Disable STP	99
4.3.1.2. STP System Configuration.....	99
4.3.1.3. Perport Configuration	101
4.3.2. SNMP.....	102
4.3.2.1. System Options	103
4.3.2.2. Community Strings	104
4.3.2.3. Trap Managers	107
4.3.3. GVRP.....	109
4.3.4. IGMP.....	110
4.3.5. LACP (Link Aggregation Control Protocol).....	111
4.3.5.1. Working Port Setting.....	111
4.3.5.2. State Activity.....	112
4.3.5.3. LACP Status.....	113
4.3.6. 802.1x Protocol	115
4.3.6.1. Enable/Disable 802.1x	115
4.3.6.2. 802.1x System Configuration.....	117
4.3.6.3. 802.1x PerPort Configuration	118
4.3.6.4. 802.1x Misc Configuration	119
4.4. STATUS AND COUNTERS.....	120
4.4.1. Port Status.....	120
4.4.2. Port Counters	121
4.4.3. System Information.....	122
4.5. REBOOT SWITCH.....	123
4.5.1. Default.....	123
4.5.2. Restart	123
4.6. TFTP UPDATE FIRMWARE	124
4.6.1. TFTP Update Firmware	124
4.6.2. Restore Configure File	125
4.6.3. Backup Configure File	126
5. APPLICATION EXAMPLES.....	127
5.1. VLAN APPLICATION USED WITH SWITCH	127

5.2.	TRUNKING APPLICATION USED WITH SWITCH	129
5.3.	“SINGLE IP – AGENT MODE” APPLICATION USED WITH SWITCH.....	130
	<i>5.3.1 Typical setup of “Single IP-Agent mode” network:</i>	<i>131</i>
5.4.	“SINGLE IP - STACKING MODE” APPLICATION USED WITH SWITCH USED WITH SWITCH	134
	<i>5.4.1 A guide to build up “Stacking Switches”.....</i>	<i>135</i>
	<i>5.4.2 An Example of Port-Base Stacking VLAN.....</i>	<i>136</i>
	<i>5.4.3 Limitaion with Trunking in Stacking mode.....</i>	<i>139</i>
5.5	COMPATIBILITY ON VIRTUAL SERVER AND “SINGLE IP”	140

1. Introduction

24+2G switch is a high performance web-managed SNMP Layer 2 switch that provides users with 24 10/100Mbps Ethernet and 2 1000Mbps Gigabit ports. This Switch has SNMP management and remote control capabilities such as “Web Cluster”. The Gigabit module, which can be copper or fiber media, supports 1000BASE-SX, 1000BASE-LX or 1000BASE-T, allowing users to increase their network response time at gigabit speeds and with great flexibility. A RS-232 serial port provides an easy way for installation and initial set-up.

Non-blocking and maximum wire speed performances are designed on all ports. The Switch not only supports Auto-Negotiation, but also Auto-MDIX function on all switched 24 10/100M RJ-45 ports and two Gigabit Copper ports in both half or full duplex mode. The Auto-MDIX function makes it convenient for the user, because it eliminates cabling on straight-line or cross-line issues.

24+2G switch provides a convenient way to operate Layer 2 management through the browser. The User-friendly drop-down menu allows the user to easily learn, control and monitor. It supports not only traditional SNMP function, but also RMON 1,2,3,9 groups for advanced network analysis. A new management tool called “**Single IP**” is implemented here to provide the administrator an access right to enter private IP domain through a single real IP. By this management tool, network manager can remotely control his far-side servers in private IP domain without being there.

The Switch also supports both port-based VLAN and Tag-based. To increase bandwidth application, it supports 7 groups with up to 4 ports Trunk, and moreover, these trunk ports provide fair-over function to provide back up when one or more ports malfunction. **A stacking mode is introduced here to enhance the ability of VLAN.** An integrated UI not only displays the link status of the stacking sets, but also gives the easy way to set up their VLAN.

Totally front access design and full LED status display ease user’s installation and inspection and maintenance efforts at rack mount environments. The extra LED display reflecting the fan status allows for quick diagnosis of over-heat issues.

1.1 Unpacking

Open the shipping carton of the Switch and carefully unpack its contents, the carton should contain the following items:

- One [24+2G](#), 24 port Fast Ethernet Layer 2 Switch.
- Mounting Kit: 2 mounting brackets and screws
- Four rubber feet with adhesive backing.
- One AC power cord.
- One RS-232 cable
- This User's Guide (Disk or CD).

Note: to get the "Stacking" feature, please install the optional Gigabit Module (purchased separately).

1.2 Installation

You can use the following guidelines when choosing a place to install the Switch.

- The surface must support at least 3 Kg of weight. Do not place heavy object on the Switch.
- Visually inspect the power cord and AC power connector.
- Make sure that there is proper heat dissipation form and adequate ventilation around the Switch.

Desktop or Shelf Installation:

When installing the Switch on the desktop of shelf, the rubber feet included with the device should first be attached. Attach these cushioning feet on the bottom at each corner of the device. Allow adequate space for ventilation between the device and the objects around it.

Rack Installation:

The [24+2G](#) switch can be mounted in an EIA standard-sized, 19-inch rack, which can be placed in a wiring closet with other equipment. To install, attach the mounting brackets on the switch side panels (one on each side) and secure them with the screws provided. Then, use the screws provided with the equipment rack to mount the switch on the rack.

Power on:

The 24+2G switch can be used with an AC power supply 90-260V AC, 50-60Hz. The AC power connector is located at the rear of the unit. The switch's power supply will adjust to the local power source automatically and may be turned on without having any or all LAN segment cables connected.

After the power switch is turned on, the LED indicators should respond as follows:

- All LED indicators will momentarily blink. This blinking of the LED indicators represents a reset of the system.
- The power LED indicator will blink while the Switch loads onboard software and performs a self-test. After approximately 20 seconds, the LED will light again to indicate the switch is in a ready state.
- The Speed, Link/Activity LED indicator may remain ON or OFF depending on every port's situation.
- The fan LED will be vanished if fan works normally, or LED goes RED if fan stop or failed.

1.3 Initial set up for management

There are two management ways can be chosen, one is out-of-band management, you work this way with a PC and connect your PC and switch through RS232 cable. The other way is in-band-management, you also work with a PC but connect your PC and switch through Ethernet network no matter local or remotely, or simply directly connect your PC and switch through an Ethernet cable. Before you activate the management function with the Switch, you have to read the instructions below carefully and do some proper setting to insure you can access the switch through your PC, then the switch devices will be replied or responded correctly as you wish.

1.3.1 out-of-band Terminal-mode Management

First, turn on your PC and execute with terminal mode program, such as, if you are in Microsoft Window environment, you may choose “super terminal “from programs that are listed for communication. Then follow the steps below:

Step 1: Set Hyper Terminal parameters on your PC

Bits Rate per second = 9600

Parity = None

Data Bits = 8

Stop Bit = 1

Flow Control = None

Step 2:

After setting the above on the PC, then connect your switch device with RS 232 cable, then type the “enter” key, then, the device will response the Main Menu to you and ask you answer the username and password. Then, Type the default value for the username and password to get further service, the default username is” **admin**” and default password “123 “. To know more about operation in this mode, please refer the instructions in chapter 4 of this manual to perform all function you want.

```
User Interface
Intelligent 24 + 2 Switch

username :
password :
```

1.3.2 In-band management through Ethernet

In addition to terminal mode operation, 24+2G switch also supports in-band management through browser, this function is much more user-friendly than terminal mode, because it can be operated through mouse on the PC screen and moreover it can be performed either locally or remotely through Ethernet.

Before you can access the switch, you have to know following things.

First you have to know the **IP Address and Subnet Mask** of both your switch and your PC. The default value of the **IP Address and Subnet Mask** within the switch can be got through terminal mode operation described in chapter 4, while the **IP Address and Subnet Mask** of PC can be found in your PC system.

Second, in general, within a network, the members in the same network domain must have the same Subnet IP unless there are routers between them, or, members in the same network domain can't talk to each others, so make sure **the communication members in the same domain must have different IP Addresses and same Subnet Mask.**

Third, If there is a DHCP server in the network domain, be sure to **enable** the DHCP function both on your PC and the switch, then save the setting and reboot the switch again (power-off-and-on once), DHCP server and its protocol will automatically assign IP address and related IP Subnet Mask and Default gateway, under this condition, you can execute your browser program in your PC and simply type **http:// IP-Address-of-switch** to access the switch through Ethernet or over Internet. But if there is no DHCP in the network, then you must follow the steps instructed below:

When there is no DHCP server in your network domain, according to the concept described above, you must modify either the PC side or switch side to match the rule “the **communication members in the same domain must have different IP Addresses and same Subnet Mask.** “, below, we try to state the steps if we modify the content of IP configuration within the switch to match the domain requirement of the PC:

Step 1: Get the IP configuration information in your PC

Step 2: Get IP configuration value used for switch from your network manager.

Get an IP Address for your switch, get IP Subnet Mask, and get default gateway IP address (if needed) from your network manager.

Step 3: Modify the IP configuration value within the switch to match the rule

In the step 3, you must use the data that get from step 2 to modify the default value within the switch, to achieve this, use terminal mode operation mentioned in 1.3.1. After modifying the IP address, Subnet Mask, Default Gateway in the switch, then save the setting and execute the browser program with `http:// IP_Address_ of_ switch`, then you may access the switch with following dialogue below. Then type user name and password to get further service. To find out more operation in this mode, please refer the instructions in chapter 3 of this manual.



1.3.3 Telnet management

In addition to local terminal mode operation, 24+2G switch supports remote management through Telnet over network or even over Internet for that environment without browser. In this mode, user also has to do the same setting as required in in-band management to the IP Configuration before executing the Telnet program. Again, after proper setting to the switch, save the setting and connect your Ethernet cable from your PC to any port of the Ethernet Switch, then you can simply typing as following at the command line to access the switch:

Telnet IP_Address_of_Switch

The following dialogue below appears, type in user name and password to login. To find out more operation in this mode, please refer the instructions in chapter 3 of this manual.

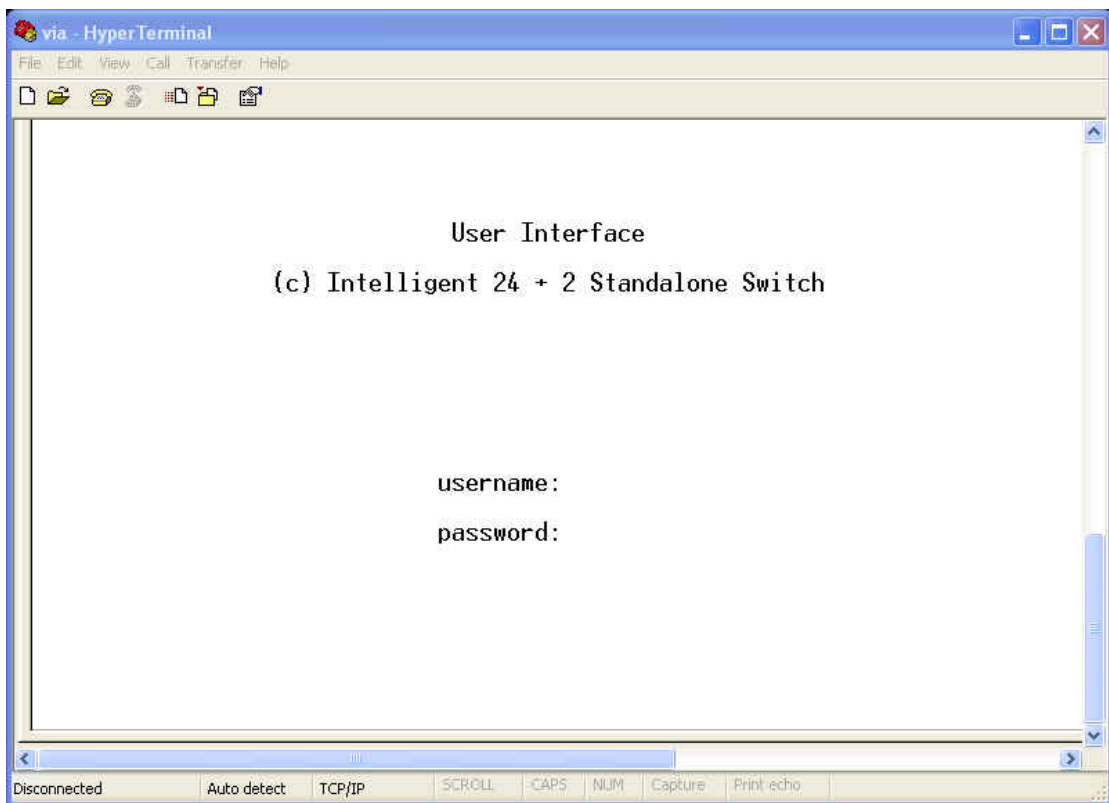

1.4 LED indicators information

There are many LEDs on the front panel of switch, after the power on, these LEDs will reflect the current status truly within the switch, we explain below:

There is one power LED on the left side of front panel, whenever power is applied, it lights with green, below it, there is Diagnostic LED, it will go blinking during the power-on diagnostics. There are two more FAN status LEDs aside the power LEDs, the upper one indicate the left fan status inside the switch, it vanishes when fan works normally, and will goes RED while fan is stop or with malfunction, the lower one indicates the same for the fan at right side within the switch.

Each RJ-45 of 10/100M is with two LEDs built-in on its upper corner, left one indicates link status and activity, while the right one indicates the speed information.

Each RJ-45 of 10/100/1000M for gigabit module (optional) is somewhat different. Upper yellow LED indicates for 10M LINK, middle green LED indicates for 100M LINK, but for 1000M, or Gigabit, both upper and middle LEDs are lit when gigabit port is link with other Gigabit port.

LED	Color	Status	
		Solid	Blinking
Power	Green	Turn solid green when power is applied to this device.	N/A
DIAG	Green	Successful diagnostic.	during power on diagnostics
FAN	Red	Left side fan fail.	N/A
LINK/ACT	Green	Successful connection with Fast Ethernet.	Sending , Receiving or collision packets
10/100M	Green	Successful connection with 100Mbps Fast Ethernet.	N/A
	Vanish	Successful connection with 10Mbps Fast Ethernet.	N/A

2. Web Management Function

2.1. Web Management Home Overview

This is a Home Page.

The screenshot shows the web management interface for a switch. At the top, there is a status bar with indicators for 'PAR FAN1', 'DIAG FAN2', and 'DCE.9600.e.8.1'. Below this, a row of 26 ports is shown, labeled 1X through 26X. The first 24 ports are grouped into pairs (2X, 4X, 6X, 8X, 10X, 12X, 14X, 16X, 18X, 20X, 22X, 24X), and the last two are labeled 25X and 26X. Each port has a 'LNK ACT' indicator. The main content area has a blue sidebar on the left with a 'Main Menu' containing: Home, Port Status, Port Statistics, Show MAC Table, Administrator, TFTP Update Firmware, Configuration Backup, Reset System, and Reboot. The main content area displays the following information:

Welcome 24+2 Intelligent Switch

Switch Information

Description	SNMP 24+2 Switch With IP Agent
MAC Address	000a17f0f02
Firmware version	v10.01.01
ASIC version	A7.00

Module Information

	TYPE	DESCRIPTION
Module1	1000TX	N/A
Module2	1000TX	N/A

At this page, you may see the basic switch information and module information. All information in these fields is read-only. That is, user can't modify its contents.

Description: Display the name of device type.

MAC Address: The unique hardware address assigned by manufacturer (default)

Firmware Version: Display the switch's firmware version.

ASIC Version: Display the switch's ASIC version.

On the top of web page, there is a link status from image of front panel; every port will be with a **connector icon** if this port is really linked with others, you also may click the function that listed at left. Below is the explanation of each function:

2-2. Port status

2-3. Port Statistics

2-4. Show MAC Table

2-5. Administrator

2-6. TFTP Update Firmware

2-7. Configuration Backup

2-8. Reset System

2-9. Reboot

2.2. Port status

This page provides current status of every port that depends on user’s setting and the negotiation result.

Port Status																
The following information provides a view of the current status of the unit.																
Port	State		Link	Negotiation		Speed		Duplex		Flow Control			Rate Control(100K)		Priority	Security
	Config	Actual		Config	Actual	Config	Actual	Config	Actual	Config	Half	Actual	Actual			
												Ingr	Egr			
PORT1	On	On	Down	Auto	Auto	100	100	Full	Full	On	On	On	Off	Off	Disable	Off
PORT2	On	On	Down	Auto	Auto	100	100	Full	Full	On	On	On	Off	Off	Disable	Off
PORT3	On	On	Down	Auto	Auto	100	100	Full	Full	On	On	On	Off	Off	Disable	Off
PORT4	On	On	Down	Auto	Auto	100	100	Full	Full	On	On	On	Off	Off	Disable	Off
PORT5	On	On	Down	Auto	Auto	100	100	Full	Full	On	On	On	Off	Off	Disable	Off
PORT6	On	On	Down	Auto	Auto	100	100	Full	Full	On	On	On	Off	Off	Disable	Off
PORT7	On	On	Down	Auto	Auto	100	100	Full	Full	On	On	On	Off	Off	Disable	Off
PORT8	On	On	Up	Auto	Auto	100	100	Full	Full	On	On	Off	Off	Off	Disable	Off
PORT9	On	On	Down	Auto	Auto	100	100	Full	Full	On	On	On	Off	Off	Disable	Off
PORT10	On	On	Down	Auto	Auto	100	100	Full	Full	On	On	On	Off	Off	Disable	Off
PORT11	On	On	Down	Auto	Auto	100	100	Full	Full	On	On	On	Off	Off	Disable	Off
PORT12	On	On	Down	Auto	Auto	100	100	Full	Full	On	On	On	Off	Off	Disable	Off
PORT13	On	On	Down	Auto	Auto	100	100	Full	Full	On	On	On	Off	Off	Disable	Off
PORT14	On	On	Down	Auto	Auto	100	100	Full	Full	On	On	On	Off	Off	Disable	Off
PORT15	On	On	Down	Auto	Auto	100	100	Full	Full	On	On	On	Off	Off	Disable	Off
PORT16	On	On	Down	Auto	Auto	100	100	Full	Full	On	On	On	Off	Off	Disable	Off
PORT17	On	On	Down	Auto	Auto	100	100	Full	Full	On	On	On	Off	Off	Disable	Off

- State:** Display port statuses: **disable or enable**. “Unlink” will be treated as “off”.
- Link Status:** Down means “No Link”, UP means “Link”.
- Auto Negotiation:** Display the auto negotiation mode: auto/force/Nway-force.
- Speed status:** Display 1000Mbps or 100Mbps or 10Mbps speed, port 1- 24 are 10/100Mbps, Port 25-26 are 10/100/1000Mbps.
- Duplex status:** Display full-duplex or half-duplex mode.
- Flow Control:** Full: Display the flow control is enabled or disabled in full mode.
Half: Display the backpressure is enabled or disabled in half mode.
- Rate Control:** Display the rate control setting.
Ingr: Display the port effective ingress rate of user setting.
Egr: Display the port effective egress rate of user setting.
- Port Security:** Display the port security is enabled or disabled.
- Config:** Display the state of user setting.
- Actual:** Display the negotiation result.

2.2.1 single port counter and status

User can also click any port directly on the front panel of Home Page to get single port Status which is shown below.

There is a flow rate historical chart on the right. User can track the flow rate of this port in the past 60 hours. Changing the scale will re-calculate the chart.

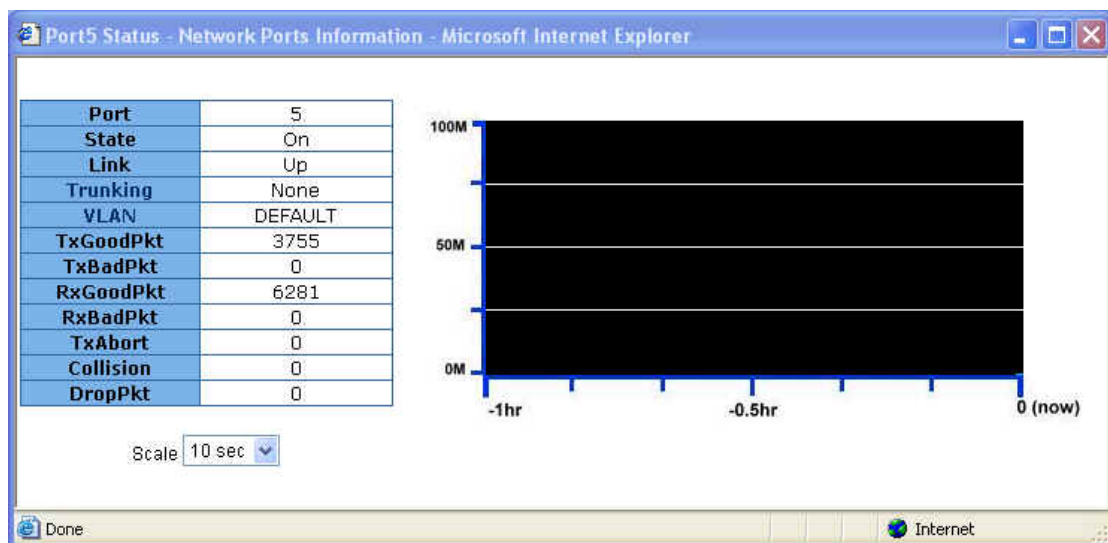

2.3. Port Statistics

The following information provides a view of the current status of the whole unit.

Press “Reset” button to clean all count.

Port Statistics

The following information provides a view of the current status of the unit.

Port	State	Link	TxGoodPkt	TxBadPkt	RxGoodPkt	RxBadPkt	TxAbort	Collision	DropPkt
PORT1	On	Down	0	0	0	0	0	0	0
PORT2	On	Down	0	0	0	0	0	0	0
PORT3	On	Down	0	0	0	0	0	0	0
PORT4	On	Down	0	0	0	0	0	0	0
PORT5	On	Down	0	0	0	0	0	0	0
PORT6	On	Down	0	0	0	0	0	0	0
PORT7	On	Down	0	0	0	0	0	0	0
PORT8	On	Up	477	0	518	0	0	0	2
PORT9	On	Down	0	0	0	0	0	0	0
PORT10	On	Down	0	0	0	0	0	0	0
PORT11	On	Down	0	0	0	0	0	0	0

Reset



2.4. Show MAC Table

The following information provides a table of the current MAC address that the switch has learned. Press “Prev” or “Next” button will browse previous 50 or next 50 items. The “Top” button will re-list the table from the first MAC.

A sorting function is implemented here. Clicking header on the top of table will bring a new sorted list of current content in the order of its title. For instance, clicking the “MAC” on the top of table will refresh the table by the index of “MAC”.

Learned MAC Table

The following information provides a table of the current MAC addresses that switch has learned.

NO	MAC	PORT	VID	TYPE
1	00-05-1C-11-BD-47	12	0	Dynamic
2	00-0C-6E-55-53-34	12	0	Dynamic
3	00-0A-E6-81-3D-E3	12	0	Dynamic
4	00-0A-17-D0-00-45	10	0	Static
5	00-0A-17-FF-00-68	6	0	Static
6	00-0A-17-00-33-33	3	0	Static
7	00-50-FC-64-68-CE	8	0	Dynamic

Total MACs in table: 7

[Prev](#) [Top](#) [Next](#)

2.5. Administrator

There are many management functions can be set or performed if you click the **Administrator** on Home Page, including:

- ◆ IP and Management mode
- ◆ Switch settings
- ◆ Console port information
- ◆ Port configuration
- ◆ Trunking
- ◆ IGMP and MAC Filter
- ◆ VLAN configuration
- ◆ Spanning tree
- ◆ Port Mirror
- ◆ SNMP/Trap Manager
- ◆ Security Manager
- ◆ 802.1x Configuration
- ◆ Ping
- ◆ Agent /Stacking Management

2.5.1. IP and Management mode

User can modify the switch IP Settings by filling with the new value, then clicks “apply” button to confirm (save) his setting, then he/she must **reboot** switch, then new IP configuration value will be activated.

The **Management mode** indicates which role this switch is currently playing. “Agent Slave” means it is treated as a normal switch. “Agent Master” means the "Single IP" is activated and the switch is treated as agent manager. ”Stacking slave” is used only when this switch is going to be a member of stacking set. This setting will force the switch to activate spanning tree protocol and some VLAN settings for preparation of stacking switches. “Stacking Master” does the same tasks too, but it plays the role of manager of the whole stacking switches. Only the “Stacking Slave” can be added into the members of a stacking set under one “Stacking master”. The default management mode is "Agent Slave".

The extra “Agent IP” setting is necessary for the “Single IP” management. It defines the IP and the subnet mask the master switch will be assigned, which are in the same IP domain as the managed

hosts' one.

User can confine the “Single IP” function to local management by assigning the agent IP to the same one as switch IP. Different from original IP forwarding method, it uses a method like webpage link and won't increase the loading of switch.

”Agent IP “setting and “Agent management” in the main menu will not show up if the agent mode is set as “Slave”.

[Note] If any of the value is changed in this field, reboot is necessary.

IP & Management Mode

DHCP :

Switch IP Address	192.168.223.100
Switch Subnet_Mask	255.255.255.0
Switch Gateway	192.168.223.254

Management Mode : (Default : Agent Slave)

- Agent Slave
- Agent Master
- Stacking Slave
- Stacking Master**

Agent IP Address	192.168.223.100
Agent Subnet_Mask	255.255.255.0

2.5.2 Switch Setting

2.5.2.1 Advanced

◆ Miscellaneous Setting:

MAC Address Age-out Time: Type the number of seconds that an inactive MAC address remains in the switch's address table. The valid range is 300~765 seconds. Default is 300 seconds.

Max bridge transit delay bound control: Limit the packets queuing time in switch. If enable, the packets queued exceed will be drop. These valid values are 1sec, 2 sec, and 4 sec and off. Default is 1 seconds.

NOTE: Make sure of “Max bridge transit delay bound control” is enabled before enable Delay Bound, because Enable Delay Bound must be work under “Max bridge transit delay bound control is enabled” situation.

Broadcast Storm Filter: To configure broadcast storm control, enable it and set the upper threshold for individual ports. The threshold is the percentage of the port's total bandwidth used by broadcast traffic. When broadcast traffic for a port rises above the threshold you set, broadcast storm control becomes active. The valid threshold value is 5%, 10%, 15%, 20%, 25% and off.

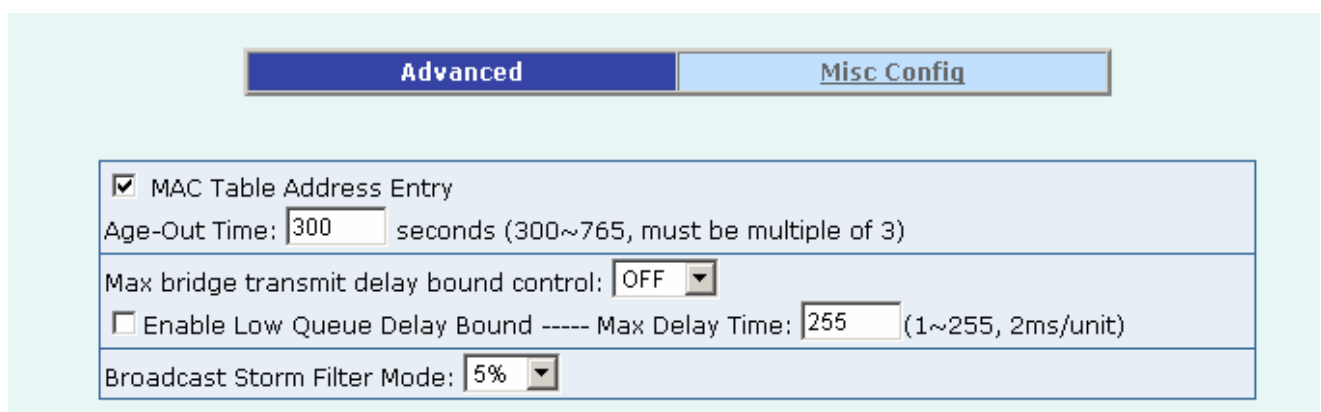

The screenshot shows a configuration window with two tabs: 'Advanced' (selected) and 'Misc Config'. The 'Misc Config' section contains the following settings:

- MAC Table Address Entry
Age-Out Time: seconds (300~765, must be multiple of 3)
- Max bridge transmit delay bound control: ▼
- Enable Low Queue Delay Bound ----- Max Delay Time: (1~255, 2ms/unit)
- Broadcast Storm Filter Mode: ▼

◆ Priority Queue Service settings:

First Come, First Serve: The sequence of packets sent is depending on arrive orders.

All High before Low: The high priority packets sent before low priority packets.

WRR: Weighted Round Robin. Select the preference given to packets in the switch's high-priority queue. These options represent the number of high priority packets sent before one low priority packet is sent. For example, 5 High : 2 Low means that the switch sends 5 high-priority packets before sending 2 low- priority packets.

Enable Delay Bound: Limit the low priority packets queuing time in switch. Default Max Delay Time is 255ms. If the low priority packet stays in switch exceed Max Delay Time, it will be sent. The valid range is 1-255ms.

Qos Policy: High Priority Levels: 0~7 priority level can map to high or low queue.

Priority Queue Service:

802.1p Priority

First Come, First Serve
 All High before Low
 WRR

----- High weight: Low weight:

Qos Policy: High Priority Levels

Level0 Level1 Level2 Level3 Level4 Level5 Level6 Level7

Apply Default Help

2.5.2.2 Misc Config

Collisions Retry Forever:

Disable – In half duplex, collision-retry maximum is 48 times and packet will be dropped if collision still happen.

Enable – In half duplex, if happen collision will retry forever.

Hash Algorithm: Choose algorithms, [CRC-Hash](#) or [DirectMap](#), to maintain MAC address table.

IFG Compensation: Enable or disable inter-frame gap (IFG) compensation.

802.1x Protocol: Enable or disable 802.1x protocol.

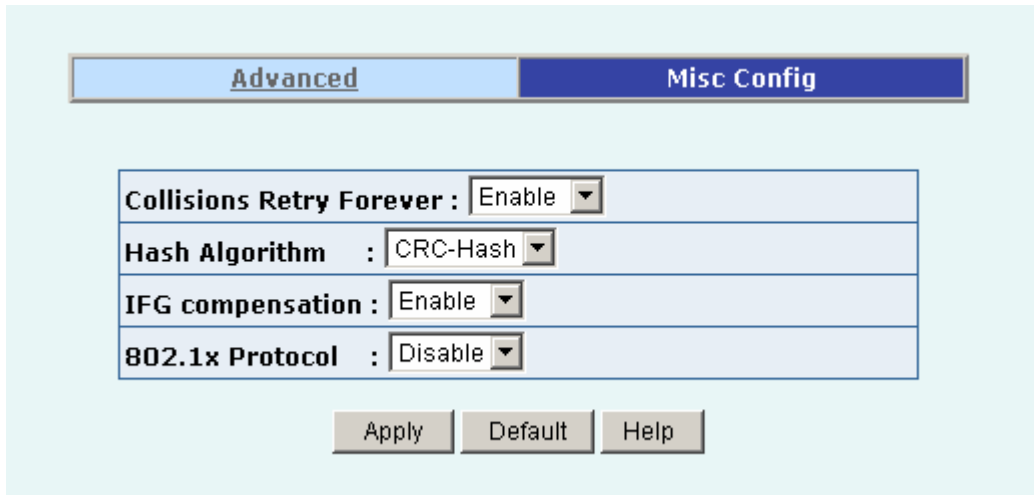

2.5.3 Console Port Information

Console is a standard UART interface to communicate with Serial Port.

User can use windows HyperTerminal program to link the switch. Connect To -> Configure:

Bits per seconds: 9600

Data bits: 8

Parity: none

Stop Bits: 1

Flow control: none

Console Information

Baudrate(bits/sec)	9600
Data Bits	8
Parity Check	none
Stop Bits	1
Flow Control	none

Help

2.5.4 Port Controls

User may modify or change mode operation in this page.

Port Controls

Port	State	Negotiation	Speed	Duplex	Flow Control		Rate Control (100K)		Priority	Security
					Full	Half	Ingress	Egress		
<div style="border: 1px solid black; padding: 2px;"> PORT7 ▲ PORT8 ▲ PORT9 ▲ PORT10 ▼ </div>	Enable ▼	Auto ▼	100 ▼	Full ▼	Enable ▼	Enable ▼	0	0	Disable ▼	<input type="checkbox"/>

Port	State		Link	Negotiation		Speed		Duplex		Flow Control		Rate Control(100K)		Priority	Security	
	Config	Actual		Config	Actual	Config	Actual	Config	Actual	Config		Actual	Ingr			Egr
										Full	Half					
PORT6	On	On	Down	Auto	Auto	100	100	Full	Full	On	On	On	Off	Off	Disable	Off
PORT9	On	On	Down	Auto	Auto	100	100	Full	Full	On	On	On	Off	Off	Disable	Off
PORT10	On	On	Down	Auto	Auto	100	100	Full	Full	On	On	On	Off	Off	Disable	Off

1. **State:** User can disable or enable this port control.
2. **Auto Negotiation:** User can set auto negotiation mode is Auto, Nway (specify the speed/duplex on this port and enable auto-negotiation), Force of per port.
3. **Speed:**
 - User can set 100Mbps or 10Mbps speed on Port1~Port24.
 - User can set 1000Mbps, 100Mbps or 10Mbps speed on Port25~Port26 (depend on module card mode).
4. **Duplex:** User can set full-duplex or half-duplex mode of per port.
5. **Flows control:**
 - Full:** User can set flow control function is enable or disable in full mode.
 - Half:** User can set backpressure is enable or disable in half mode.
6. **Rate Control:** port1 ~ port 24, supports by-port ingress and egress rate control. For example, assume port 1 is 10Mbps, users can set its effective egress rate at 1Mbps and ingress rate at 500Kbps. Device will perform flow control or backpressure to confine the ingress rate to meet the specified rate.

Ingress: Type the port effective ingress rate. The valid range is 0 ~ 1000. The unit is 100K.

0: disable rate control.

1 ~ 1000: valid rate value

Egress: Type the port effective egress rate. The valid range is 0~1000. The unit is 100K.

0: disable rate control.

1 ~ 1000: valid rate value.

7. **Port Priority:** Enable or disable the port priority function. There are two priorities (high or low) provided if port priority is enabled.
8. **Port Security:** A port in security mode will be “locked” without permission of address learning. Only the incoming packets with SMAC already existing in the address table can be forwarded normally. User can disable the port from learning any new MAC addresses, then use the static MAC addresses screen to define a list of MAC addresses that can use the secure port. Enter the settings, then click Apply button to change on this page.

2.5.5 Trunking

The Link Aggregation Control Protocol (LACP) provides a standardized means for exchanging information between Partner Systems on a link to allow their Link Aggregation Control instances to reach agreement on the identity of the Link Aggregation Group to which the link belongs, move the link to that Link Aggregation Group, and enable its transmission and reception functions in an orderly manner. In conclusion, Link aggregation lets you group up to eight consecutive ports into a single dedicated connection. This feature can expand bandwidth to a device on the network. **LACP operation requires full-duplex mode**, more detail information refers to IEEE 802.3ad

2.5.5.1 Aggregator setting

Trunking		
Aggregator Setting	Aggregator information	State Activity
System Priority		
1		
Group ID	Group1	<< Get
LACP	Enable	
Work Ports	4	
PORT1 PORT2 PORT3 PORT4	<< Add << Remove >>	PORT5 PORT6 PORT7 PORT8 PORT9 PORT10 PORT11 PORT12 PORT13
Apply Delete Help		

- System Priority:** A value used to identify the active LACP. The switch with the lowest value has the highest priority and is selected as the active LACP. Valid value is 1~65535.
- Group ID:** There are seven trunk groups to provide configure. Choose the "group id" and click "Get".
- LACP:** If enable, the group is LACP static trunking group. If disable, the group is local static trunking group. All ports support LACP dynamic trunking group. If connecting to the device that also

supports LACP, the LACP dynamic trunking group will be created automatically.

- 4. Work ports:** Allow max four ports can be aggregated at the same time. If LACP static trunking group, the exceed ports is standby and able to aggregate if work ports fail. If local static trunking group, the number must be as same as the group member ports.
- 5.** Select the ports to join the trunking group. Allow max four ports can be aggregated at the same time.
- 6.** If LACP enable, you can configure LACP Active/Passive status in each port on State Activity page.
- 7.** Click Apply.

2.5.5.2 Aggregator Information

When you are setting LACP aggregator, you can see relation information in here.

- 1.** This page is no group active. LACP don't working.

The screenshot shows a web interface titled "Trunking" with three tabs: "Aggregator Setting", "Aggregator information", and "State Activity". The "Aggregator information" tab is selected. Below the tabs, a message states "The following information provides a view of LACP current status." followed by the text "NO GROUP ACTIVE".

- 2.** This page is Static Trunking groups.

The screenshot shows the same web interface as above, but with the "State Activity" tab selected. Below the tabs, a message states "The following information provides a view of LACP current status." followed by two tables representing static trunking groups.

Static Trunking Group	
Group Key	1
Port_No	1 2 3 4

Static Trunking Group	
Group Key	2
Port_No	7 8 9 10

- 3.** This page is Actor and Partner trunking one group.

The following information provides a view of LACP current status.

Group 1						
Actor				Partner		
Priority	0			1		
MAC	000a17ff0f02			000a17ff0f05		
PortNo	Key	Priority	Active	PortNo	Key	Priority
PORT1	513	1	selected	PORT21	513	1
PORT2	513	1	selected	PORT22	513	1
PORT3	513	1	selected	PORT23	513	1
PORT4	513	1	selected	PORT24	513	1

2.5.5.3 State Activity

Active (select): The port automatically sends LACP protocol packets.

N/A (no select): The port does not automatically sends LACP protocol packets, and responds only if it receives LACP protocol packets from the opposite device.

1. A link that has either two active LACP ports or one active port can perform dynamic LACP trunking. A link has two N/A LACP ports will not perform dynamic LACP trunking because both ports are waiting for and LACP protocol packet from the opposite device.
2. If you are active LACP's actor, when you are select trunking port, the active status will be created automatically.

Aggregatort Setting		Aggregatort information		State Activity	
Port	LACP State Activity	Port	LACP State Activity		
1	<input checked="" type="checkbox"/> Active	2	<input checked="" type="checkbox"/> Active		
3	<input checked="" type="checkbox"/> Active	4	<input checked="" type="checkbox"/> Active		
5	N/A	6	N/A		
7	<input checked="" type="checkbox"/> Active	8	<input checked="" type="checkbox"/> Active		
9	<input checked="" type="checkbox"/> Active	10	<input checked="" type="checkbox"/> Active		
11	N/A	12	N/A		
13	N/A	14	N/A		
15	N/A	16	N/A		
17	N/A	18	N/A		
19	N/A	20	N/A		
21	N/A	22	N/A		
23	N/A	24	N/A		
25	N/A	26	N/A		

2.5.6 Filter Database

2.5.6.1. IGMP Snooping

The 24+2G switch supports multicast IP. One can enable IGMP protocol on this web page, and then display the IGMP snooping information on this page. There are all multicast groups, VIDs and member ports in the list. IP multicast addresses range from 224.0.0.0 through 239.255.255.255.

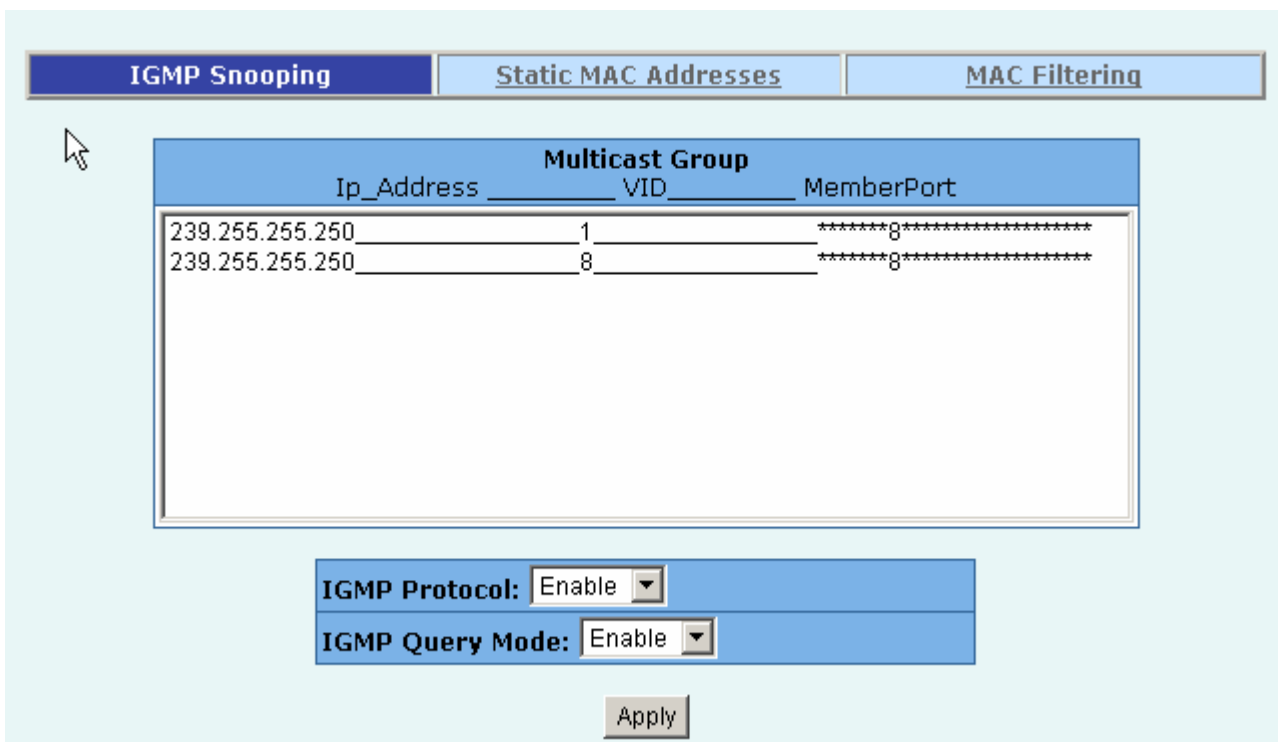

The Internet Group Management Protocol (IGMP) is an internal protocol of the Internet Protocol (IP) suite.

IGMP can manage the multicast traffic if the members (switches, router or other network devices) of group support IGMP. With IGMP enable, the member ports will detect IGMP queries, report packets and manage the IP multicast traffic through the switch.

IGMP have three fundamental types of message as follows:

Message	Description
Query	A message sent from the queries (IGMP router or switch) asking for a response from each host belonging multicast group.
Report	A message sent by a host to the queries to indicate that the host wants to be or is a member of a given group indicated in the report message.
Leave Group	A message sent by a host to the queries to indicate that the host has quit being a member of a specific multicast group.

2.5.6.2. Static MAC Address

When you add a static MAC address, it remains in the switch's address table, regardless of whether the device is physically connected to the switch. This saves the switch from having to re-learn a device's MAC address when the disconnected or powered-off device is active on the network again.

The screenshot shows the 'Static MAC Addresses' configuration page. At the top, there are three tabs: 'IGMP Snooping', 'Static MAC Addresses' (which is selected), and 'MAC Filtering'. Below the tabs, a message states: 'Static addresses currently defined on the switch are listed below. Click Add to add a new static entry to the address table.' A table displays the current static MAC addresses:

MAC Address	PORT	VID
000a17003333	PORT1	0
000a17000355	PORT3	0
000a17000348	PORT8	0

Below the table is a form for adding a new static entry with the following fields:

- Mac Address**: A text input field.
- Port num**: A dropdown menu currently showing 'PORT1'.
- Vlan ID**: A text input field currently showing 'N/A'.

At the bottom of the page, there are several navigation buttons: 'Prev 50', 'Top', 'Next 50', 'Add', 'Delete', and 'Help'.

1. At the main menu, click administrator → Filter Database → Static MAC Address.
2. In the MAC address box, enter the MAC address to and from which the port should permanently forward traffic, regardless of the device's network activity.
3. In the Port Number box, enter a port number.
4. If tag-based (IEEE 802.1Q) VLANs are set up on the switch, static addresses are associated with individual VLANs. Type the VID (tag-based VLANs) to associate with the MAC address.
5. Click the Add.
6. Click the "Prev 50" will list the previous 50 MAC addresses.
7. Click the "Top" will refresh the list from the first entry.
8. Click the "Next 50" will list the next 50 MAC addresses.

2.5.6.3 MAC filtering

MAC address filtering allows the switch to drop unwanted traffic. Traffic is filtered based on the destination addresses.

Specify a MAC address to filter.

MAC Address	VID
000a17dd0001	0
000a17dd0003	0
000a17dd0016	0

Mac Address

Vlan ID

1. In the MAC Address box, enter the MAC address that wants to filter.
2. If tag-based (802.1Q) VLAN are set up on the switch, in the VLAN ID box, type the VID to associate with the MAC address.
3. Click the Add.
4. Choose the MAC address that you want to delete and then click the Delete.

2.5.7. VLAN configuration

A Virtual LAN (VLAN) is a logical network grouping that limits the broadcast domain. It allows you to isolate network traffic so only members of the VLAN receive traffic from the same VLAN members. Basically, creating a VLAN from a switch is logically equivalent of reconnecting a group of network devices to another Layer 2 switch. However, all the network devices are still plug into the same switch physically.

The 24+2G switch supports port-based, 802.1Q (tagged-based) and protocol-based VLAN in web management page. In the default configuration, VLAN support is disabling.

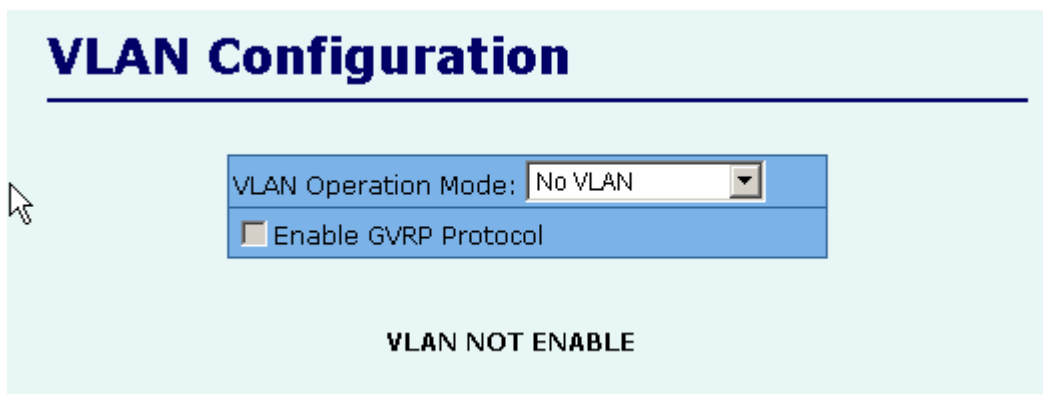

◆ Support Port-based VLAN

Packets can only be broadcast among members of the same VLAN group. Note all unselected ports are treated as belonging to another single VLAN. If the port-based VLAN enabled, the VLAN-tagging is ignored.

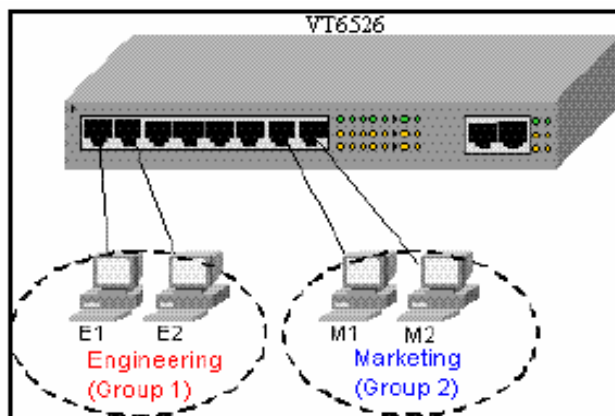

◆ **Support Tag-based VLAN (IEEE 802.1Q VLAN)**

Tagged-based VLAN is an IEEE 802.1Q specification standard. Therefore, it is possible to create a VLAN across devices from different switch vendors. IEEE 802.1Q VLAN uses a technique to insert a “tag” into the Ethernet frames. Tag contains a VLAN Identifier (VID) that indicates the VLAN numbers.

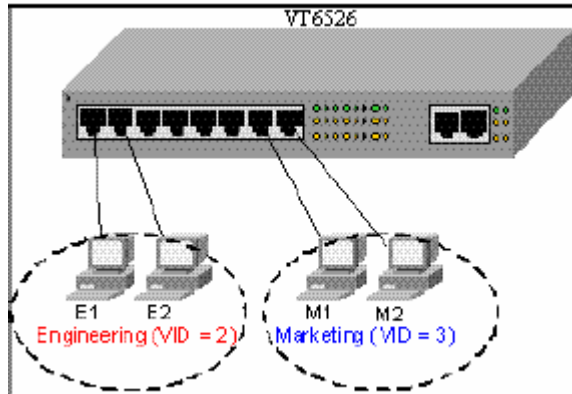

◆ **Support Protocol-based VLAN**

In order for an end station to send packets to different VLANs, it itself has to be either capable of tagging packets it sends with VLAN tags or attached to a VLAN-aware bridge that is capable of classifying and tagging the packet with different VLAN ID based on not only default PVID but also other information about the packet, such as the protocol.

24+2G switch will support protocol-based VLAN classification by means of both built-in knowledge of layer 2 packet formats used by selected popular protocols, such as Novell IPX and AppleTalk’s Ether Talk, and some degree of programmable protocol matching capability.

2.5.7.1. Port Based VLAN

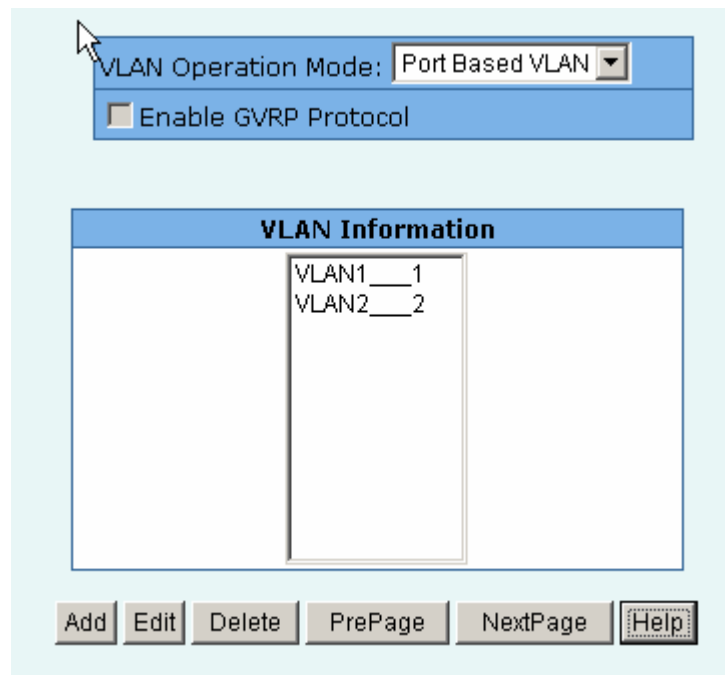

1. Click Add to create a new VLAN group.
2. Enter the VLAN name, group ID and select the members for the new VLAN.
3. Click Apply.
4. If there are many groups that over the limit of one page, you can click the “Next Page” to view other VLAN groups.

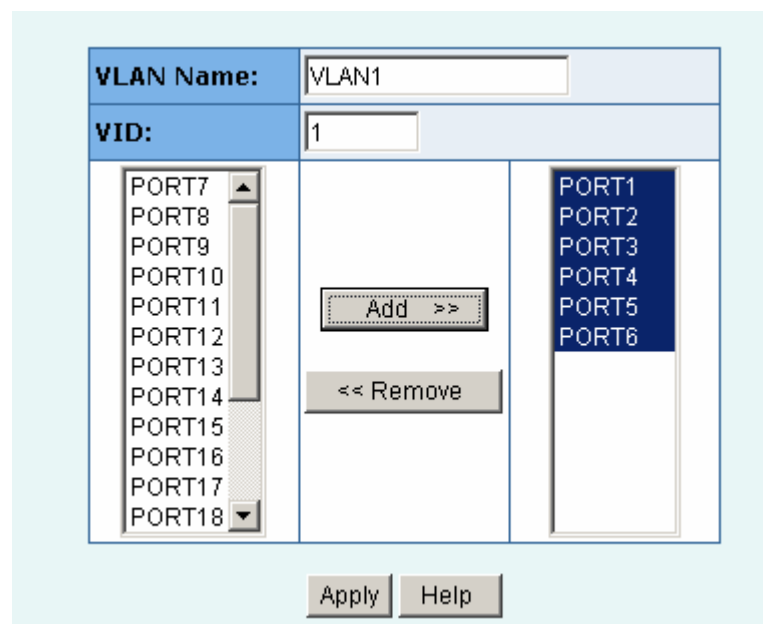

NOTE: If the trunk groups exist, you can see it (ex: TRK1, TRK2...) in select menu of ports, and you can configure it is the member of the VLAN or not.

2.5.7.2. 802.1Q VLAN

This page, user can create Tag-based VLAN, and enable or disable GVRP protocol.

There are 256 VLAN groups to provide configure. Enable 802.1Q VLAN, the all ports on the switch belong to default VLAN, VID is 1. The default VLAN can't be deleted.

The screenshot shows a web-based configuration interface for VLANs. At the top, there is a dropdown menu for 'VLAN Operation Mode' set to '802.1Q' and a checkbox for 'Enable GVRP Protocol' which is currently unchecked. Below this is a navigation bar with two tabs: 'Basic' (selected) and 'Port VID'. The main content area is titled 'VLAN Information' and contains a table with one entry: 'DEFAULT__1'. At the bottom of the interface, there are several buttons: 'Add', 'Edit', 'Delete', 'PrePage', 'NextPage', and 'Help'.

GVRP (GARP [Generic Attribute Registration Protocol] VLAN Registration Protocol)

GVRP allows automatic VLAN configuration between the switch and nodes. If the switch is connected to a device with GVRP enabled, you can send a GVRP request using the VID of a VLAN defined on the switch, the switch will automatically add that device to the existing VLAN.

◆ *Basic*

Create a VLAN and add tagged member ports to it.

1. From the main menu, click Administrator → VLAN configuration, click Add then you will see the page as follow.

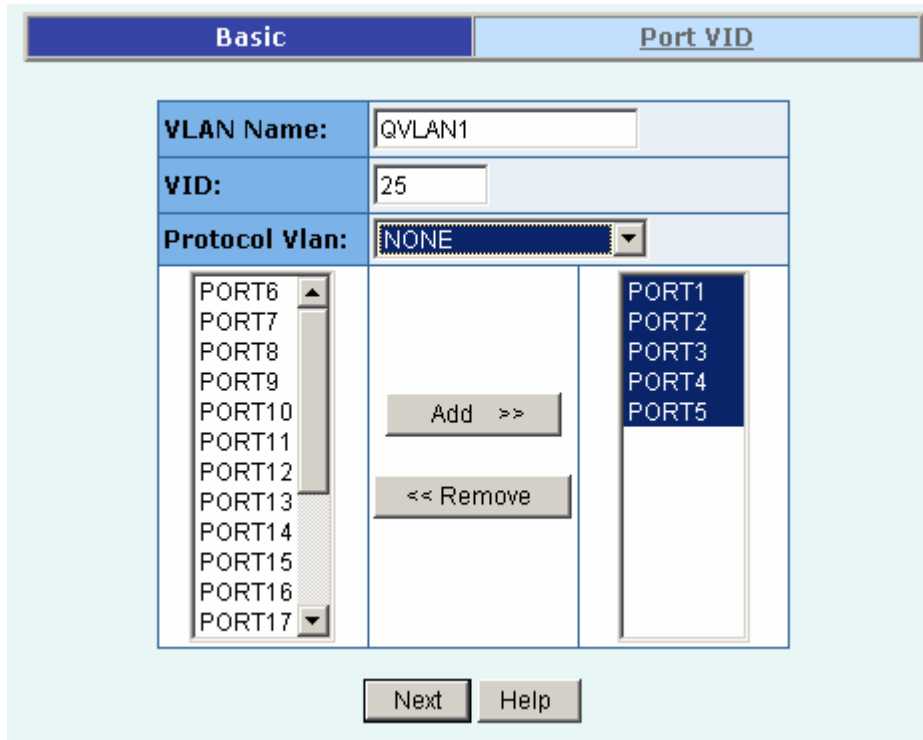

2. Type a name for the new VLAN.
3. Type a VID (between 2-4094). The default is 1.
4. Choose the protocol type.

We support **802.1v** with the implementation of Port-and-Protocol-based VLAN classification. User can combine the field “**Protocol Vlan**” and the field of the **port number** to form a new VLAN group.

NOTE:

IEEE 802.1v provides user to classify the packet through untagged port. There are two possible strategies of the 802.1v supporting: Port-based VLAN and Port-and-Protocol-based VLAN. We can support both Port-based VLAN and Port-and-Protocol-based VLAN with our product. User set the VID to mark the packet from untagged port. Then, the packet can be scheduled by the way of the IEEE 802.1q.

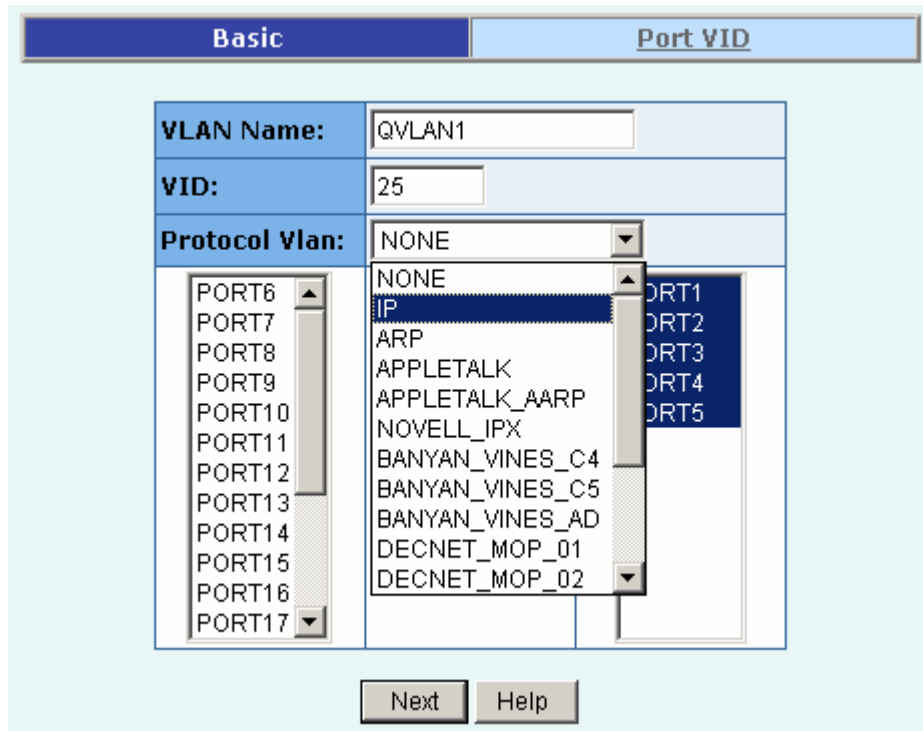

5. From the Available ports box, select ports to add to the switch and click “Add >>”. If the trunk groups exist, you can see it in here (ex: TRK1, TRK2...), and you can configure it is the member of the VLAN or not.
6. Click Next. Then you can view the page as follow :

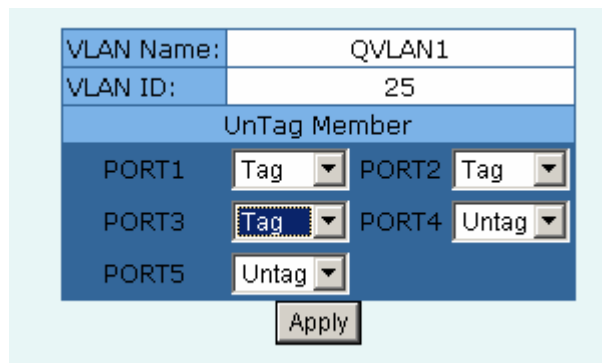

7. Uses this page to set the outgoing frames are VLAN-Tagged frames or no. Then click Apply.
Tag: outgoing frames with VLAN-Tagged.
Untag: outgoing frames without VLAN-Tagged.

◆Port VID

Configure port VID settings

From the main Tag-based (IEEE 802.1Q) VLAN page, click Port VID Settings.

VLAN Operation Mode: 802.1Q
 Enable GVRP Protocol

Basic Port VID

Assign a Port VLAN ID (1~255) for untagged traffic on each port, then click Submit to apply the changes on this page.

Ingress Filtering Rule 1 (Forward only packets with the configured VID)
Ingress Filtering Rule 2 (Drop Untagged Frame)

NO	PVID	Ingress Filtering 1	Ingress Filtering 2
PORT1 PORT2 PORT3 PORT4	1	Enable	Disable

Apply Default Help

NO	PVID	Ingress Filtering 1	Ingress Filtering 2
PORT1	1	ENABLE	DISABLE
PORT2	1	ENABLE	DISABLE
PORT3	1	ENABLE	DISABLE
PORT4	1	ENABLE	DISABLE

Port VID (PVID)

Set the port VLAN ID that will be assigned to untagged traffic on a given port. This feature is useful for accommodating devices that you want to participate in the VLAN but that don't support tagging. 24+2G switch each port allows user to set one PVID, the range is 1~255, default PVID is 1. The PVID must as same as the VLAN ID that the port belong to VLAN group, or the untagged traffic will be dropped.

Ingress Filtering

Ingress filtering lets frames belonging to a specific VLAN to be forwarded if the port belongs to that VLAN. 24+2G switch has two ingress filtering rule as follows:

Ingress Filtering Rule 1: A forward only packet with VID matching this port's configured VID.

Ingress Filtering Rule 2: Drop Untagged Frame.

2.5.8. Spanning Tree

The Spanning-Tree Protocol (STP) is a standardized method (IEEE 802.1D) for avoiding loops in switched networks. Enable STP to ensure that only one path at a time is active between any two nodes on the network.

You can enable Spanning-Tree Protocol on web management's switch setting advanced item, select enable Spanning-Tree protocol. We are recommended that you enable STP on all switches ensures a single active path on the network.

1. You can view spanning tree information about the Root Bridge. Such as follow screen.

Priority	32768
Mac Address	000a17ff0f02
Root_Path_Cost	0
Root Port	0
Max Age	20
Hello Time	2
Forward Delay	15

2. You can view spanning tree status about the switch. Such as follow screen.

PortNum	PathCost	Priority	PortState
PORT1	10	128	FORWARDING
PORT2	10	128	FORWARDING
PORT3	10	128	FORWARDING
PORT4	10	128	FORWARDING
PORT5	10	128	FORWARDING
PORT6	10	128	FORWARDING
PORT7	10	128	FORWARDING
PORT8	10	128	FORWARDING
PORT9	10	128	FORWARDING
PORT10	10	128	FORWARDING
PORT11	10	128	FORWARDING
PORT12	10	128	FORWARDING
PORT13	10	128	FORWARDING
PORT14	10	128	FORWARDING
PORT15	10	128	FORWARDING

3. You can setting new value for STP parameter, then click set Apply button to modify

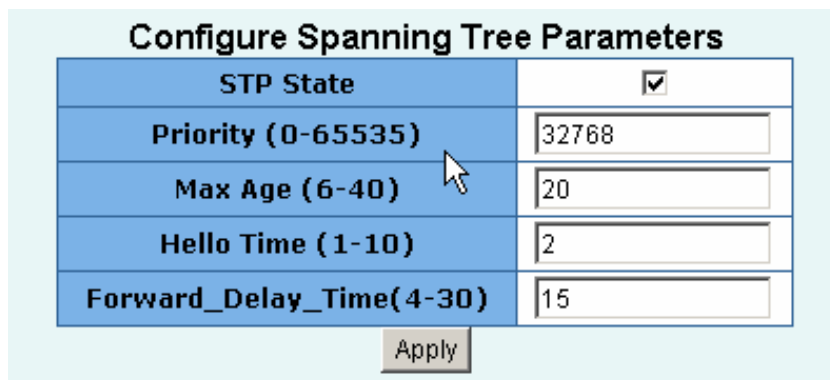

Parameter	Description
Priority	You can change priority value, A value used to identify the root bridge. The bridge with lowest value has the highest priority and is selected as the root. Enter a number 1 through 65535.
Max Age	You can change Max Age value, The number of second bridge waits without receiving Spanning-Tree Protocol configuration messages before attempting a reconfiguration. Enter a number 6 through 40.
Hello Time	You can change Hello time value, the number of seconds among the transmission of Spanning-Tree Protocol configuration messages. Enter a number 1 through 10.
Forward Delay time	You can change forward delay time, The number of seconds a port waits before changing from its Spanning-Tree Protocol learning and listening states to the forwarding state. Enter a number 4 through 30.

4. The following parameter can be configured on each port , click set Apply button to modify

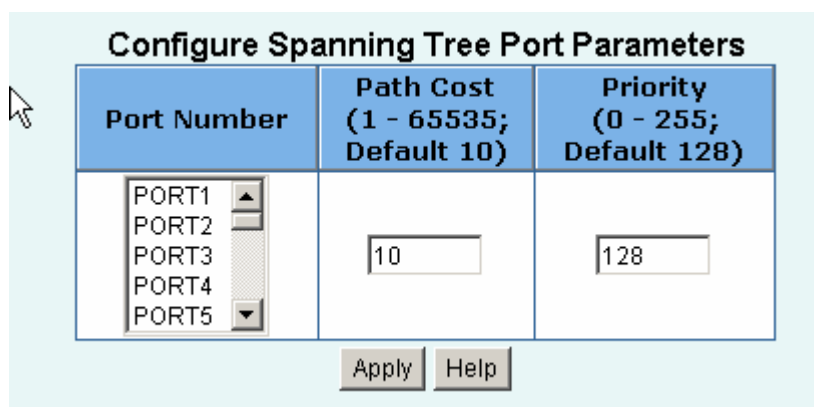

Parameter	Description
Port Priority	You can make it more or less likely to become the root port, the rage is 0-255,default setting is 128 The lowest number has the highest priority.
Path Cost	Specifies the path cost of the port that switch uses to determine which port are the forwarding ports the lowest number is forwarding ports, the rage is 1-65535 and default value base on IEEE802.1D 10Mb/s = 50-600 100Mb/s = 10-60 1000Mb/s = 3-10

2.5.9. Port Mirror

The Port Mirror is a method for monitor traffic in switched networks. Traffic through ports can be monitored by one specific port. That is, traffic goes in or out monitored ports will be duplicated into Analysis port.

- 1. Roving Analysis Mode:** Press **Space** key to set mirror mode: Disable \Rx \Tx \Both.
- 2. Analysis Port:** It' means this port can be used to see all monitors port traffic. You can connect analysis port to LAN analyzer or netxray.
- 3. Monitored Port:** The ports you want to monitor. All monitor port traffic will be copied to analysis port. You can select max 25 monitor ports in the switch. User can choose which port that they want to monitor in only one mirror mode.

If you want to disable the function, you must select monitor port to none.

Mirror Port Configuration

Roving Analysis State:	BOTH	▼
Analysis Port:	PORT1	▼
Port	Monitor	
PORT1	<input type="checkbox"/>	
PORT2	<input checked="" type="checkbox"/>	
PORT3	<input checked="" type="checkbox"/>	
PORT4	<input checked="" type="checkbox"/>	
PORT5	<input checked="" type="checkbox"/>	
PORT6	<input checked="" type="checkbox"/>	
PORT7	<input type="checkbox"/>	
PORT8	<input type="checkbox"/>	
PORT9	<input type="checkbox"/>	

2.5.10. SNMP/Trap Manager

Any Network Management platform running the simple Network Management Protocol (SNMP) can manage the switch, provided the Management Information Base (MIB) is installed correctly on the management station. The SNMP is a Protocol that governs the transfer of information between management station and agent.

1. **System Options** : Use this page to define management stations as trap managers and to enter SNMP community strings. User can also define a name, location, and contact person for the switch. Fill in the system options data, and then click Apply to update the changes on this page.

Name: Enter a name to be used for the switch.

Location: Enter the location of the switch.

Contact: Enter the name of a person or organization.

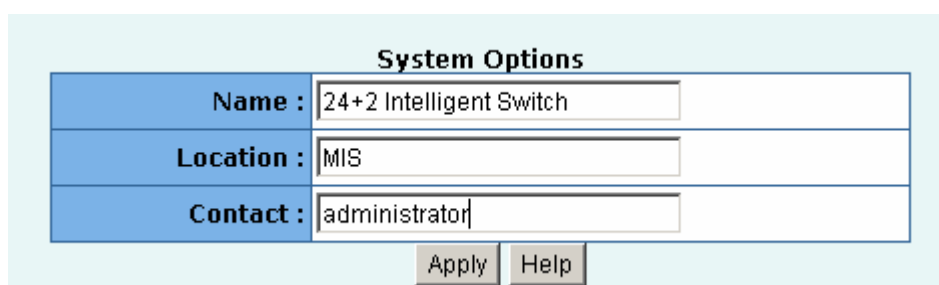

System Options	
Name :	24+2 Intelligent Switch
Location :	MIS
Contact :	administrator

Apply Help

2. **Community strings** serve as passwords and can be entered as one of the following:
 - RO: Read only.** Enables requests accompanied by this string to display MIB-object information.
 - RW: Read write.** Enables requests accompanied by this string to display MIB-object information and to set MIB objects.

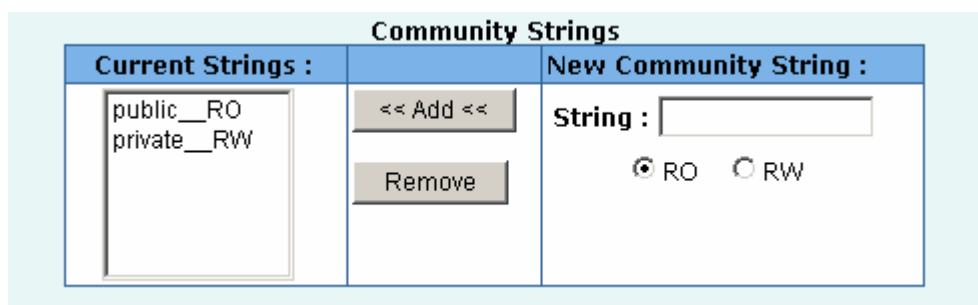

Community Strings	
Current Strings :	New Community String :
public__RO private__RW	String : <input type="text"/>
<< Add << Remove	<input checked="" type="radio"/> RO <input type="radio"/> RW

3. **Trap Manager** : A trap manager is a management station that receives traps, the system alerts generated by the switch. If no trap manager is defined, no traps are issued. Create a trap manager by entering the IP address of the station and a community string.

Trap Managers

Current Managers :		New Manager :
<input type="text" value="192.168.1.1"/>	<input type="button" value=" << Add <<"/> <input type="button" value=" Remove"/>	IP Address : <input type="text" value="192.168.1.254"/> Community : <input type="text" value="private"/>

2.5.11 Security Manager

On this page, user can change user name and password with following steps.

1. **User name:** Type the new user name.
2. **Password:** Type the new password.
3. **Reconfirm password:** Retype the new password.
4. **Click Apply.**

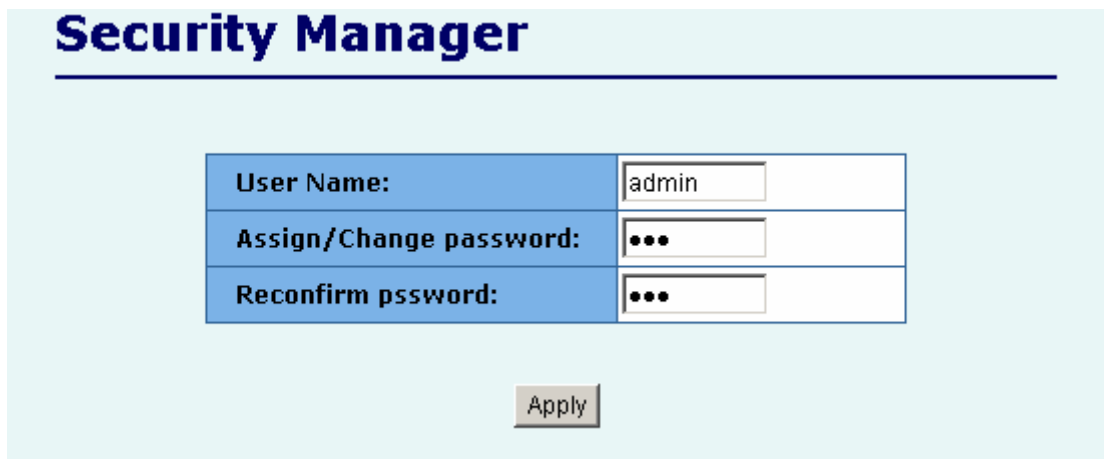

The screenshot displays the 'Security Manager' interface. It features a light blue background with a dark blue header containing the text 'Security Manager' and a horizontal line. Below the header is a form with three rows of input fields. The first row is labeled 'User Name:' and contains the text 'admin'. The second row is labeled 'Assign/Change password:' and contains three black dots. The third row is labeled 'Reconfirm pssword:' and also contains three black dots. Below the form is a button labeled 'Apply'.

User Name:	admin
Assign/Change password:	•••
Reconfirm pssword:	•••

Apply

2.5.12 802.1x Configuration

System Configuration

802.1x makes use of the physical access characteristics of IEEE802 LAN infrastructures in order to provide a means of authenticating and authorizing devices attached to a LAN port that has point-to-point connection characteristics, and of preventing access to that port in cases in which the authentication and authorization process fails.

To enable 802.1x, from **Administrator \Switch setting \Advanced** then you still to fill in the authentication server information :

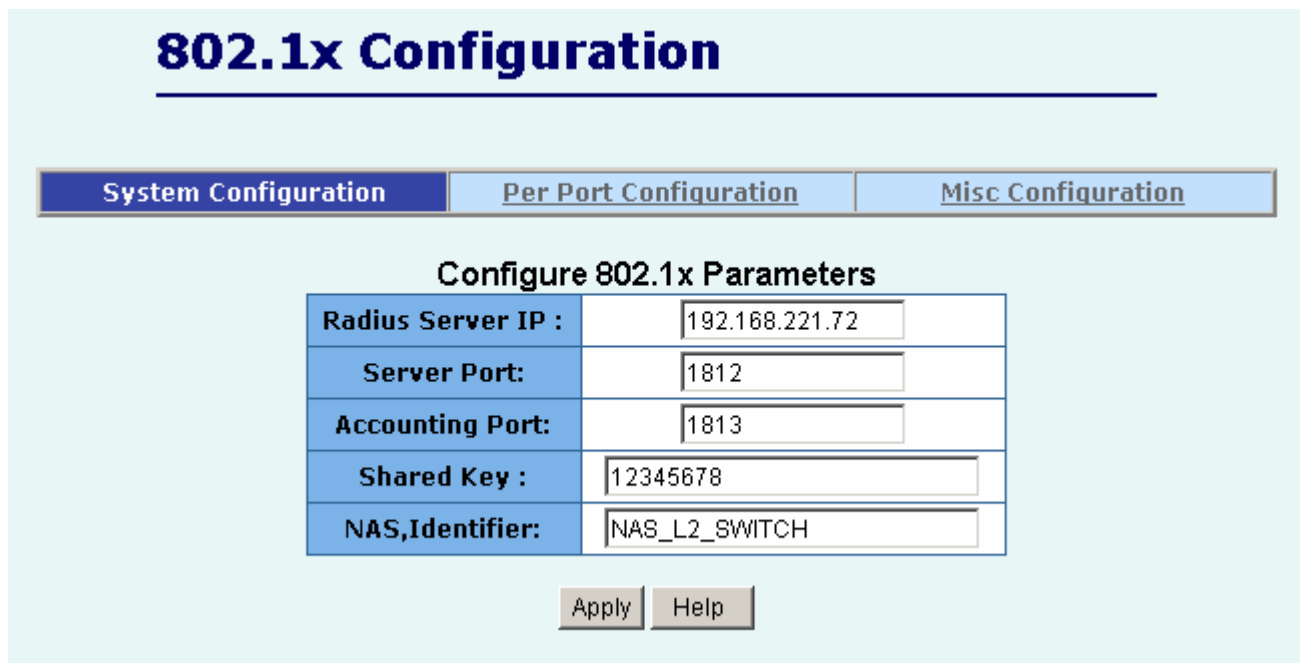

802.1x Configuration

System Configuration | Per Port Configuration | Misc Configuration

Configure 802.1x Parameters

Radius Server IP :	192.168.221.72
Server Port:	1812
Accounting Port:	1813
Shared Key :	12345678
NAS,Identifier:	NAS_L2_SWITCH

Apply Help

Radius Server IP Address: the IP address of the authentication server.

Server Port: The UDP port number used by the authentication server to authenticate. **Accounting**

Port: The UDP port number used by the authentication server to retrieve accounting information.

Shared Key: A key shared between this switch and authentication server.

NAS, Identifier: A string used to identify this switch.

Perport Configuration

In this page, you can select the specific port and configure the Authorization State.

Each port can select four kinds of Authorization State:

Configure 802.1x Per Port State

Port Number	Port State
<div style="border: 1px solid gray; padding: 2px;"> PORT1 ▲ PORT2 ▲ PORT3 ▲ PORT4 ▼ PORT5 ▼ </div>	<div style="border: 1px solid gray; padding: 2px; display: inline-block;"> Au ▼ </div>

Fu : Force the specific port to be unauthorized.

Fa : Force the specific port to be authorized.

Au : The state of the specific port was determined by the outcome of the authentication.

No : The specific port didn't support 802.1x function.

Misc Configuration

In this page, you can change the default configuration for the 802.1x standard:

Configure 802.1x misc configuration

Quiet period:	60
Tx period:	30
Supplicant timeout:	30
Server timeout:	30
Max requests:	2
Reauth period:	3600

Quiet Period : Used to define periods of time during which it will not attempt to acquire a supplicant (Default time is 60 seconds).

Tx Period : Used to determine when an EAPOL PDU is to be transmitted (Default value is 30 seconds).

Supplicant Timeout : Used to determine timeout conditions in the exchanges between the supplicant and authentication server (Default value is 30 seconds).

Server Timeout : Used to determine timeout conditions in the exchanges between the authenticator and authentication server (Default value is 30 seconds).

Max requests : Used to determine the number of re-authentication attempts that are permitted before the specific port becomes unauthorized (Default value is 2 times).

Reauth Period : Used to determine a nonzero number of seconds between periodic re-authentication off the supplications (Default value is 3600 seconds).

2.5.13 Ping

This switch provides a simplified ping function for user to check whether a IP is on line or not.

Ping IP Address

Please input the host Ip to be pinged and count number, then press the **Apply** button.

IP Address	<input type="text" value="192.168.223.254"/>
Send Counts	<input type="text" value="5"/>

Input the IP Address and counts of ping packet to send. Press “Apply” to continue next page.

Ping IP Result

This page provides the result of pinging host IP. Press the **Stop** button to stop pinging and return.

Ping Setting

IP Address	<input type="text" value="192.168.223.254"/>
Send Counts	<input type="text" value="5"/>

Reply form the device

Reply Counts	<input type="text" value="5"/>
---------------------	--------------------------------

This page will display the result of the pinging IP . It continues updating the “Reply Counts” when the ping packets are sending. User can interrupt the progress by clicking “Stop” button.

If the reply counts remain zero after webpage reload stops, it could mean that the pinged host of this IP does not exist.

2.5.14 Agent /Stacking Management

This switch provides a new management tool for user to manage a group of LAN switches by an IP agent method. “Single IP” is the name, meaning that the administrator can access other network devices through one single IP device.

Different from the method of router's NAT (from virtual IP domain to real IP domain), single IP provides a reverse access (from real IP domain to virtual IP domain) by an IP-forwarding technology. With this IP-agent method, network administrator can remotely control his far-side hosts without being there, for he/she can access the private domain hosts through the agency of one real IP switch with “Single IP” .

There are maximum 32 sets of information of network devices stored in the single IP switch and 16 sets in Stacking switch. Basically these network devices should provide http or telnet service for the single IP switch to forward those protocol packets; meanwhile SNMP protocol can be also passed through if they support SNMP service.

More over, this single IP switch has no exclusiveness, meaning that administrator can group up network devices of any type (router, switch, server...) or brand without worrying their incompatibility.

However, for stacking switch, only the switches of the same model can detect each other and transfer information to their partner, so it won't support other network devices. This is the major difference between single IP agent mode and stacking mode. [Please read Chapter 5 for more applications.](#)

Stacking Management

Agent Control Port :
(28000~30000 recommended)

NO	IP	HOST	Action	Auto Discover List
1	192.168.223.15	Stack 01	<input type="button" value="Find >>"/> <input type="button" value="<< Add"/> <input type="button" value="Delete"/>	192.168.223.15 192.168.223.55 192.168.223.66
2	192.168.223.55	Stack 02		
3	192.168.223.66	Stack 03		

IP Address	<input style="width: 90%;" type="text" value="192.168.223.66"/>	<input type="button" value="Add / Edit"/>
Host Name(Max 15 letters)	<input style="width: 90%;" type="text" value="Stack 03"/>	

VLAN Mode

2.5.14.1 Management Web UI

Web UIs of “Agent Management” and “Stacking Management” look similar.

In this page, user can add or delete managed network devices here. If user disables the IP agent function, that is, he/she sets the management mode to “Agent Slave” or “Stacking Slave” in the IP setting webpage, this item will not show up in the main menu.

Agent Control Port: The control port defines the specific TCP/UDP port the single IP switch is listening, which the agent manager sends its command to. Agent manager use this specific port to tell single IP switch to change the current forwarding target host. The range of available port number is 28000 ~ 30000. Ignore the default settings of “Agent Control Port” unless user has the special need for this protocol port, like virtual server. The default port number is 28019.

Agent Control Port : (28000~30000 recommended)	28019	Apply
--	-------	-------

There are two ways to add the members: “Auto-discover” and “Manual”.

Auto-discover method:

Press “Find >>” and the found stackable switches will be gathered in “Auto Discover List”. Select these found members and press “<< Add” to add the selected hosts to the list.

The searching range bases on **Class C IP domain within Agent IP**. Changing “Agent IP” domain in “Administrator/IP & Management Mode” webpage will alter the search range. For example, Agent IP is set to 192.168.223.100, and then the auto-discover function will search available switches in the range from 192.168.223.1 to 192.168.223.255.

NO	IP	HOST	Action	Auto Discover List
			<input type="button" value="Find >>"/> <input type="button" value="<< Add"/> <input type="button" value="Delete"/>	192.168.223.15 192.168.223.55 192.168.223.66 192.168.223.77 192.168.223.88 192.168.223.147

Note: “Stacking Master” finds the “Stacking Slaves” only, while “Agent Master” will find all slaves and masters.

Manual method:

User can add members by manual. Fill up the “IP Address” and “Host Name”, then press “Apply” to complete the addition of a new member.

NO	IP	HOST	Action	Auto Discover List
1	192.168.223.15	Slave 01	<input type="button" value="Find >>"/> <input type="button" value="<< Add"/> <input type="button" value="Delete"/>	<div style="border: 1px solid gray; width: 100%; height: 100%;"></div>
2	192.168.223.55	Slave 02		
3	192.168.223.66	Slave 03		
4	192.168.223.77	192.168.223.77		
5	192.168.223.88	192.168.223.88		
6	192.168.223.147	192.168.223.147		

IP Address	<input type="text" value="192.168.223.77"/>	<input type="button" value="Add / Edit"/>
Host Name(Max 15 letters)	<input type="text" value="Slave 04"/>	

Editing an existing member is also easy thing to do. Select the host which needs to edit and the “IP address” and “Host Name” will appear what you choose. Modify the “Host Name” only for advice. For any IP is not within the member list, the modification will assume to add a new member. Press “Apply” to confirm the modification.

To delete an existing member, choose the host and press “Delete”. Then the host will be removed from the list.

Launch Manager: This button launches the agent manager.

VLAN Mode

For “Stacking mode”, there is an extra option “VLAN Mode” for user to choose which type of VLAN the stacking switch will carry on. There are “802.1Q” and “Port-base” VLAN .

Note:

For the cause of http authentication mechanism, it happens that web browser keeps asking administrator to input login name and password when agent manager changes a new host. Typically web browser will keep the authentication key of the successful login host and passes it to next other WebPages. Since single IP switch remains its URL of the master switch IP no matter what the agent manager has change the forwarding host, new host will still receive the same authentication key as the master switch when it requests the login authentication. If the new host has the different username and password from the master switch, authentication failure and reentry thus happens.

It is strongly recommended that the administrator changes the usernames and passwords of the managed hosts to the same ones as master switch.

2.5.14.2 Agent Manager

A floating menu will show up after clicking “Launch Agent Manager” in the agent management.

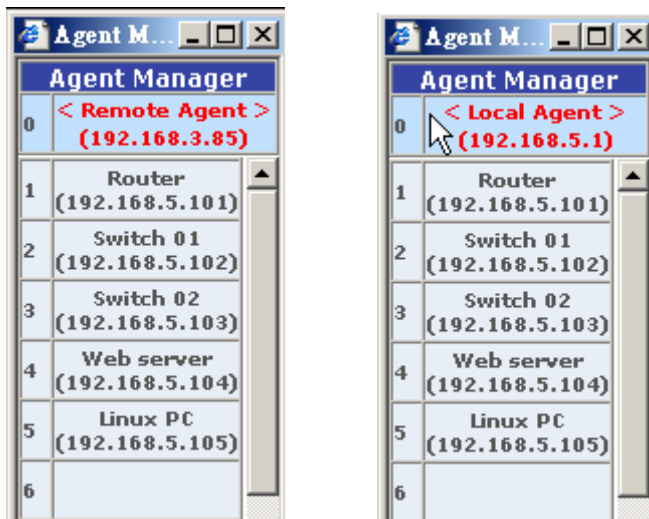

The agent manager holds 32+1 slots in the floating menu. The most top slot (zero slot) displays the master switch IP and its relative location. “Remote Agent” means that the user comes from the other IP domain than the managed ones, while “Local Agent”, that user comes from the same one as the managed ones.

There are differences between “Remote Agent” and “Local Agent”. The “Local Agent”, we refer to it as “Local Single IP”, uses a method like URL link and the main browser window will directly jump to the target host. Since the URL of web browser has change, authentication will request once again when new host is selected.

Due to consideration of switch loading, a restriction confines here that only one remote user can access the agent manager in the same time. Other user will be rejected if someone has launched the agent manger first. **The switch will release the control of single IP access in 25 seconds after the previous user closes his agent manager.** For “Local Single IP”, there is no restriction, but if a remote user has launched the agent manager in the same time, the local user is also denied.

Note: Commands from agent manager can not pass over current management level, meaning that, in case that a slave host is a single IP switch with its agent function enable, user launch the slave host’s agent manager and he/she will find the agent manager is replaced by the slave’s one. Much worst, commands to pick the slave hosts will case unexpected forwarding error here.

We strongly recommend that a single IP switch should not activate the IP agent manager when it is a slave host of active master switch.

2.5.14.3 Stacking Manager

After addition of stacking members, press "Launch manager" to pop up the "Stacking Manager".

This web UI provides not only the integrated VLAN management, but also a handy IP agent. Administrator can easily access other detail configurations in one individual switch of stacking set by clicking the hostname on the right side of this panel and jumping to its configuration webpage.

Link Status

The first page shows the current link status of all stacking members. Link-up ports will glow in their port numbers. An off-line switch will dim to gray if it does not respond to the information request from the stacking master in a period of time. This characteristic provides an easy method for network diagnose. Network administrator can check backbones connection of stacking switches at a glance of this panel.

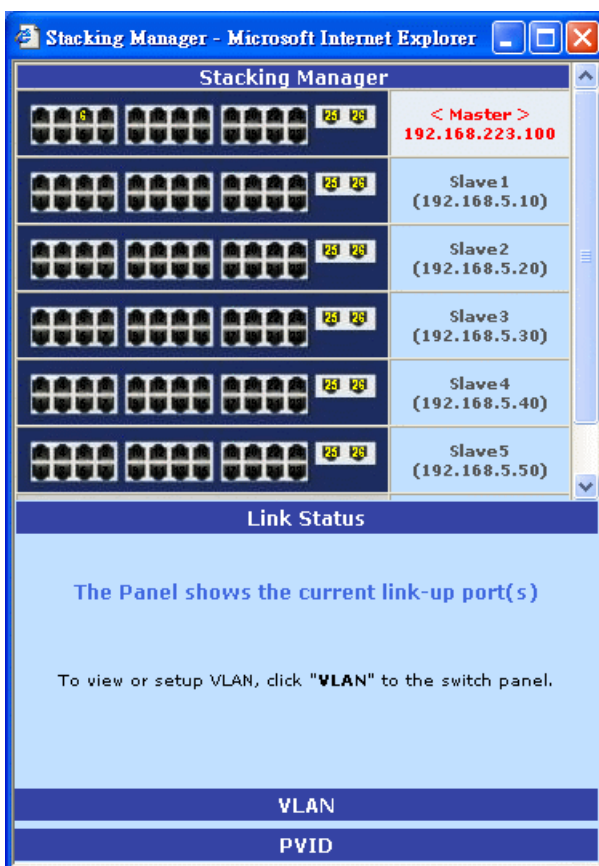

VLAN SETUP

To configure the VLAN setting of the stacking switch, click "VLAN" to bring up the VLAN configuration panel.

There are two default VLAN existing in the stacking switches.

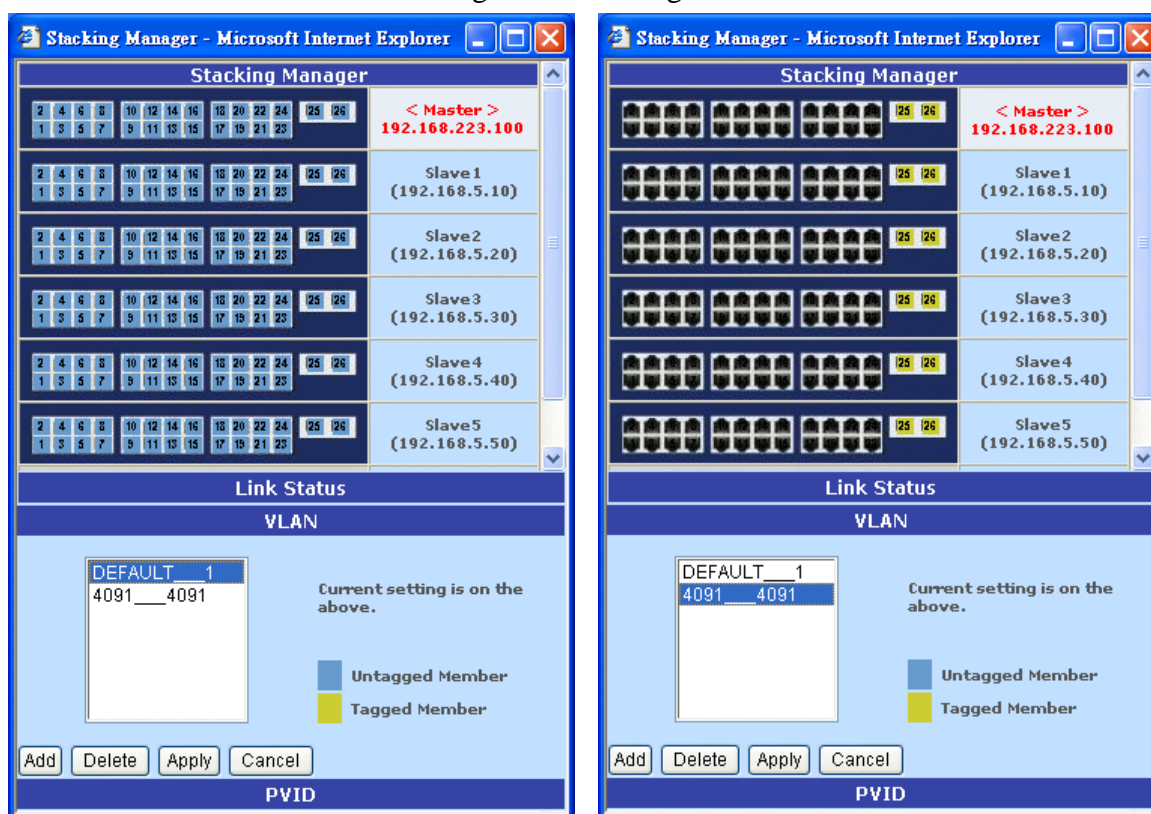

As seen above, the VLAN name " DEFAULT" and VID " 1" is standard setting for general Tag VLAN , and all port are added as untagged port; The other VLAN " 4091" , as so called " Stacking Tag VLAN" , is an unique setting for this type of stacking. And all of their Giga ports are set to tag members to form a VLAN connection channel.

A strong warning declares here that the **Stacking Tag VLAN is highly restricted to be modified or removed**, for incorrect operation will ruin the connection of stacking switches. What condition and how to change the Stacking Tag VLAN will discuss in next section.

To Add a new VLAN, press " Add" the VLAN Panel. They will come out two script prompt to ask user to input VLAN name and VLAN ID.

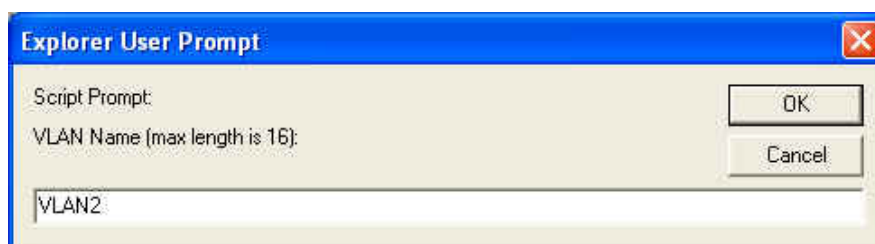

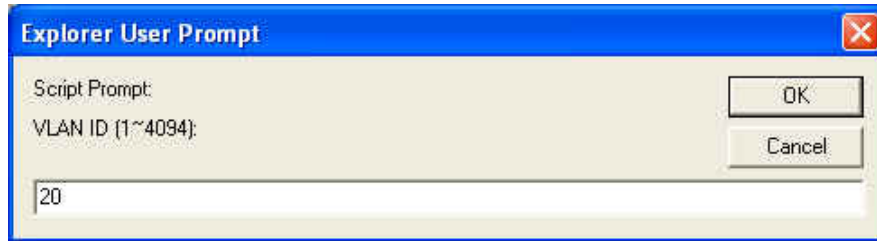

After input, user can choose the VLAN member in the Stacking Manager panel by clicking the designated port. Color cycling from blue, yellow to black means that the port is set to untagged port, tagged port or no member. When finishing , press " Apply" to submit.

It is always wise to remember that the Giga ports of each member switch are set to tagged port and keeping at least one member port in the master switch.

The stacking switches interchange VLAN information through the Giga ports which are set to tagged members by "Stacking Tag VLAN", so a new VLAN should keep its Giga ports as tagged ones. Since the master switch holds all VLAN group information, the master switch should have the right to access the new VLAN by adding at least one Giga port to it s tagged member. An exclusion of all master switch ports leads to unmanageability on this VLAN, for master switch has no such VLAN in its internal table.

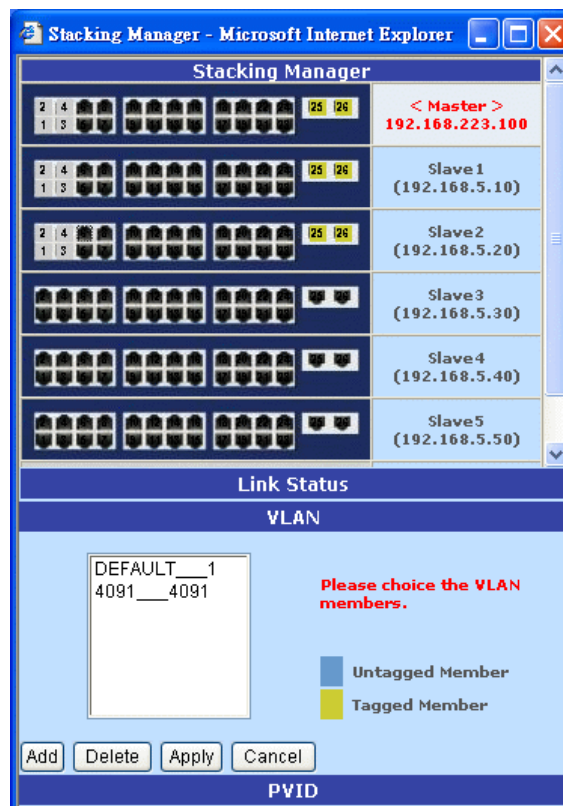

Edit or Delete a VLAN

To edit an existing VLAN, just select the VLAN from the VLAN panel and modify the members

in the Stacking Manager panel. After done, press " Apply" to submit the setting.

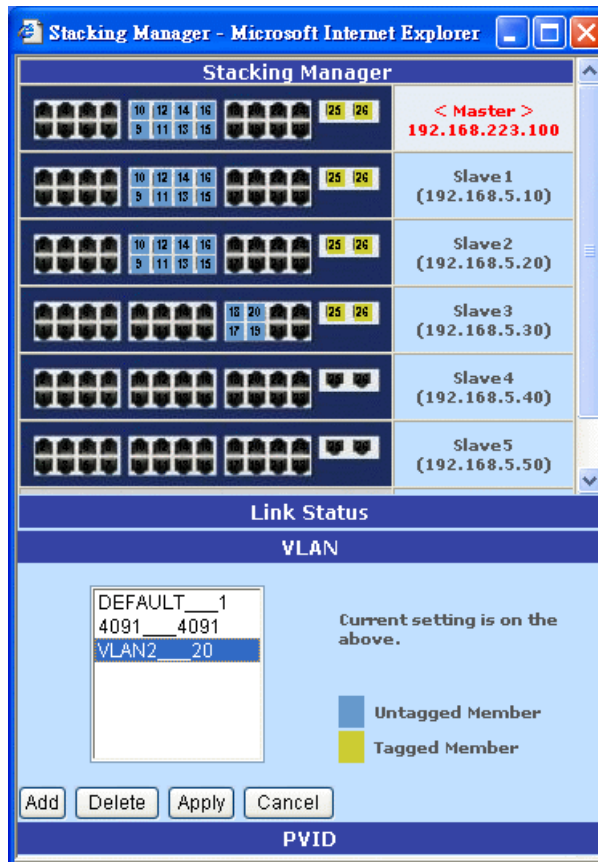

To delete a VLAN is also an easy task. Select the unwanted VLAN and press " Delete" to remove it.

There are two special cases for deleting VLAN: **The "DEFAULT VLAN" and "Stacking Tag VLAN" are undeletable!** A error message will pop up to cancel the task. **Stack VLAN also can't be edited.**



PVID SETUP

The default PVID value of all ports of 802.1Q VLAN is 1. Hence only default VLAN (PVID = 1) has all of ports as members in the beginning.

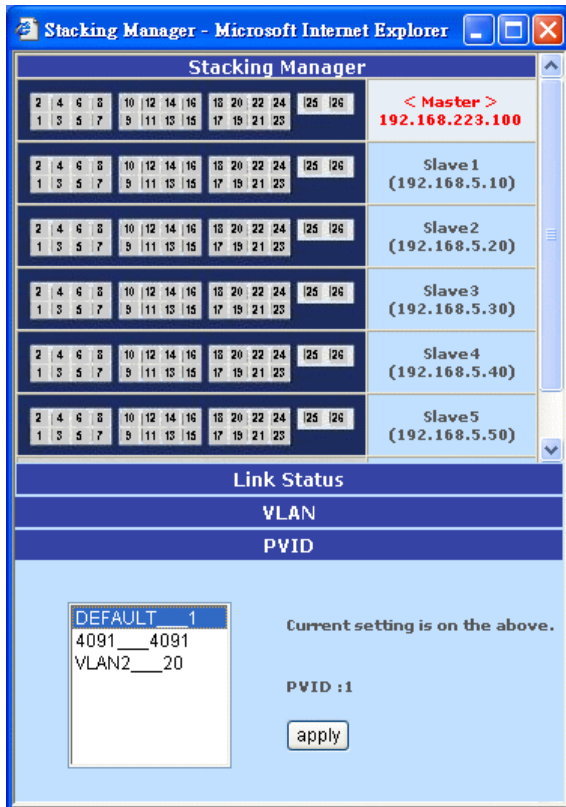

The available PVIDs are based on the VLANs that user created in the previous “VLAN” page.

1. Select the PVID to be modified and choose the ports for this PVID value.
2. Click “Apply” button to submit and a message ”Please wait” to notice user to wait patiently.
3. When message “Current setting is on ...” shows up, the task is done.

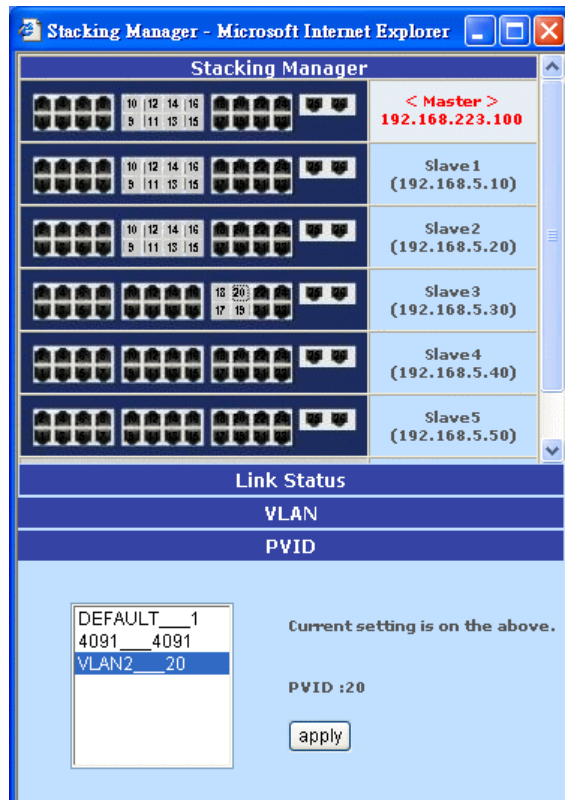
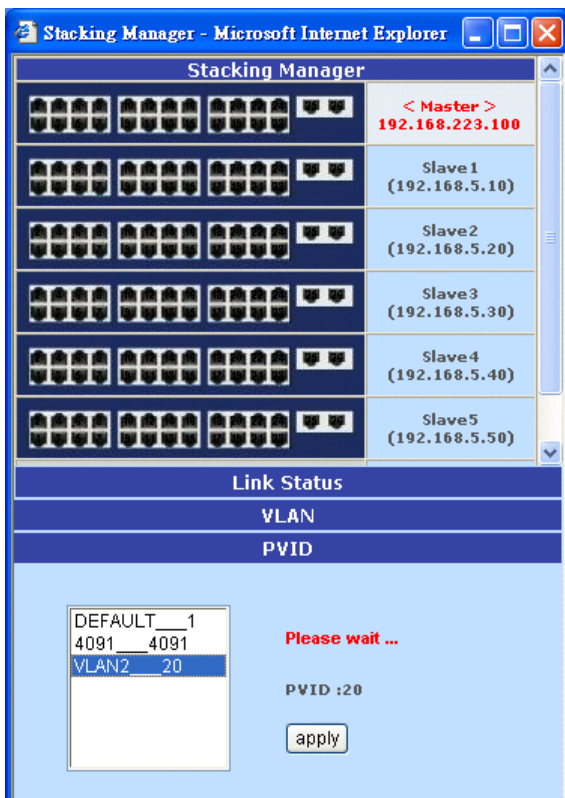

2.6. TFTP Update Firmware

1. The following menu options provide some system control functions to allow a user to update firmware and remote boot switch system:

- * Install TFTP program (such as Turbo98, or Cisco TFTP) and then execute.
- * Copy updated firmware **image.bin** into TFTP server's directory.
- * In web management select administrator—TFTP update firmware.
- * Download new **image.bin** file by pressing <update firmware>.
- * After update finished, press <reboot> to restart switch.

TFTP Download New Image

TFTP Server IP Address	192.168.223.99
Firmware File Name	image.bin

Image download complete.
Would you make sure to update firmware?

Reboot Switch System

2.7. Configuration Backup

2.7.1. TFTP Restore Configuration

Use this page to set ftp server address. You can restore EEPROM value from here, but you must put back image in ftp server, switch will download back flash image.

TFTP Configuration

TFTP Restore Configuration	TFTP Backup Configuration
-----------------------------------	----------------------------------

TFTP Server IP Address	<input type="text" value="192.168.3.87"/>
Backup File Name	<input type="text" value="data.dat"/>

2.7.2. TFTP Backup Configuration

Use this page to set tftp server ip address. You can save current EEPROM value from here, then go to the TFTP restore configuration page to restore the EEPROM value.

TFTP Configuration

TFTP Restore Configuration	TFTP Backup Configuration
-----------------------------------	----------------------------------

TFTP Server IP Address	<input type="text" value="192.168.3.87"/>
Backup File Name	<input type="text" value="data.dat"/>

2.8. Reset System

Reset Switch to default configuration, default value as below

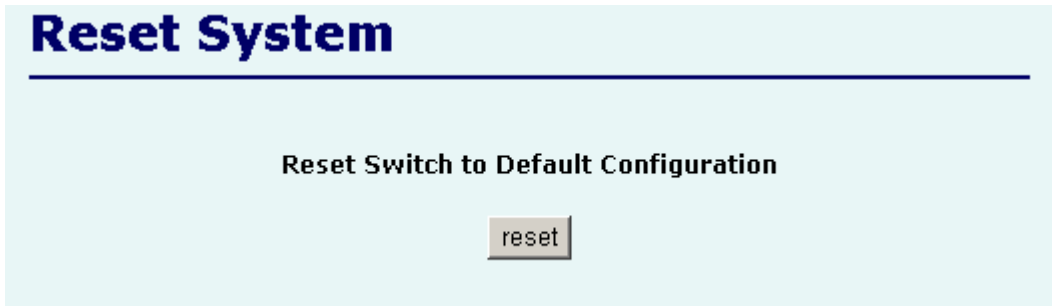

2.9. Reboot

Reboot the Switch in software reset.

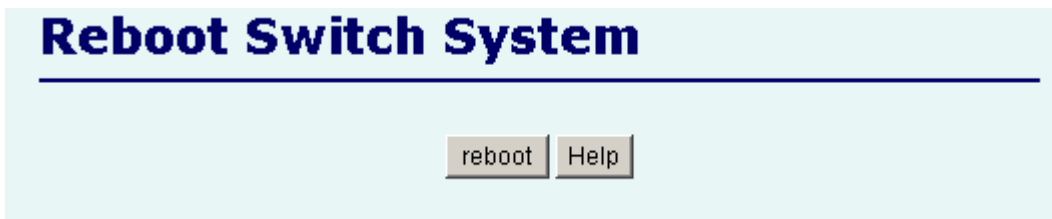

2.10. Event Logging

A history log is provided here to give a track about events that the switch had happened. There are 100 loggings for maximum capacity of this switch. The latest event will overwrite the oldest one. All records will be kept in flash memory even after writing default, unless user clears the event log.

Press “Prev” or “Next” button will browse previous 25 or next 25 sequences. The “Top” button will re-list the table from the latest event. “Clear” button will clear all history.

Event logger displays the real time according to the time zone where user is.

Event Logging

The following information provides a log of the recent events that switch has happened.

Now is: Sunday, January 11, 2004 7:49:06 PM

Seq.	Time	Event Description
13	Sunday, January 11, 2004 7:40:48 PM	User from IP 192.168.1.82 login the Web.
12	Sunday, January 11, 2004 7:37:56 PM	User from IP 192.168.223.99 login the Web.
11	Sunday, January 11, 2004 7:35:46 PM	Switch power on and System is up.
10	Sunday, January 11, 2004 7:34:07 PM	IP or Gateway was changed .
9	Sunday, January 11, 2004 7:31:20 PM	User from IP 192.168.223.99 login the Web.
8	Sunday, January 11, 2004 7:15:36 PM	Console timeout.
7	Sunday, January 11, 2004 7:13:55 PM	User from IP 192.168.223.99 login the Web.
6	Sunday, January 11, 2004 7:13:17 PM	Console login.
5	Sunday, January 11, 2004 7:12:32 PM	Switch power on and System is up.
4	After system up 0 day(s) 0:3:10	Console login.
3	After system up 0 day(s) 0:2:24	Console timeout.

3. Console -- 1K Xmodem update firmware

We provide the 1k X modem to update firmware on console. 1K X modem only works in 57600bps mode. So you must change boudrate to 57600bps to download firmware.

There are 2 cases to use 1k X modem to update firmware:

- a. **User** enters "1K X modem receiver mode" through pressing any key within 5 seconds after system power on.
- b. System automatically enters "1K X modem receiver mode" if it detects the firmware checksum fail while booting.

1. Press disconnect button when you start 1K X modem modes.

Press **File -> Properties**, change boudrate to 57600bps, then press **OK**.

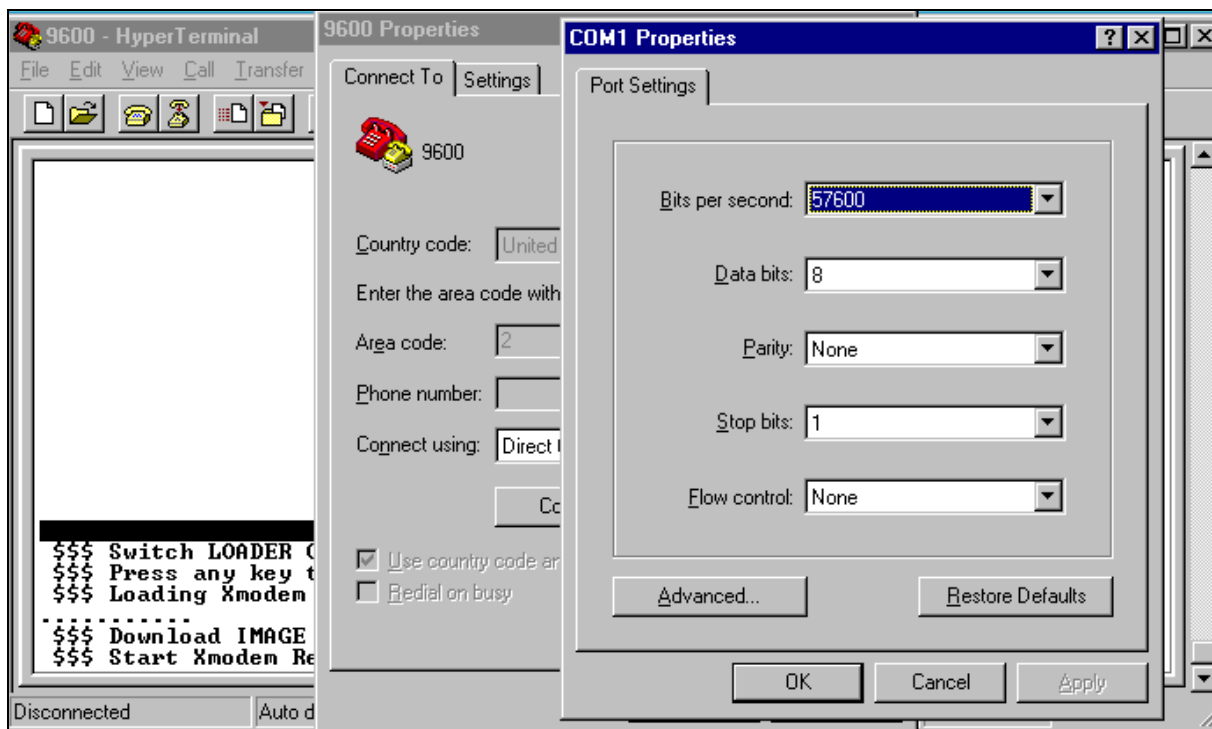

2. Press connected, you will see “CCCC...” displayed on console.
Then select *Transfer Send File*.

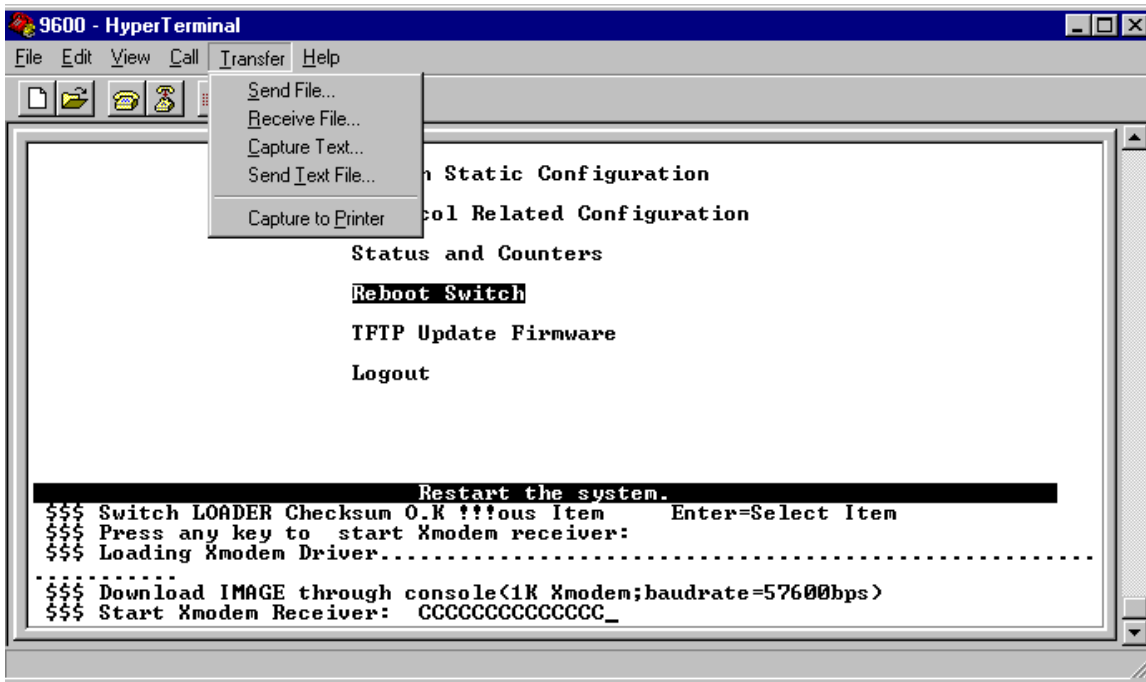

3. Select *1K Xmodem* in the *Protocol* item, and give the place that image file folder. Press *Send* button.

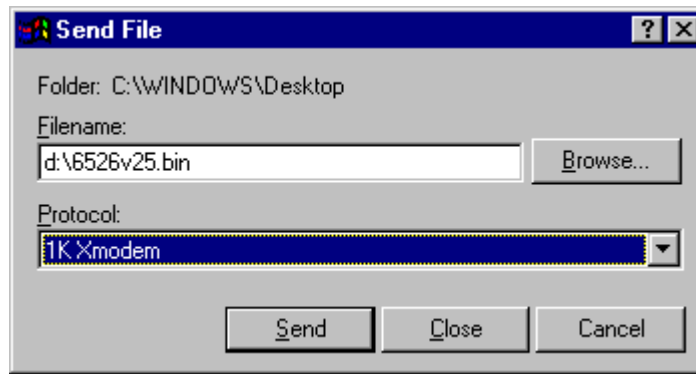

4. Start download image file.

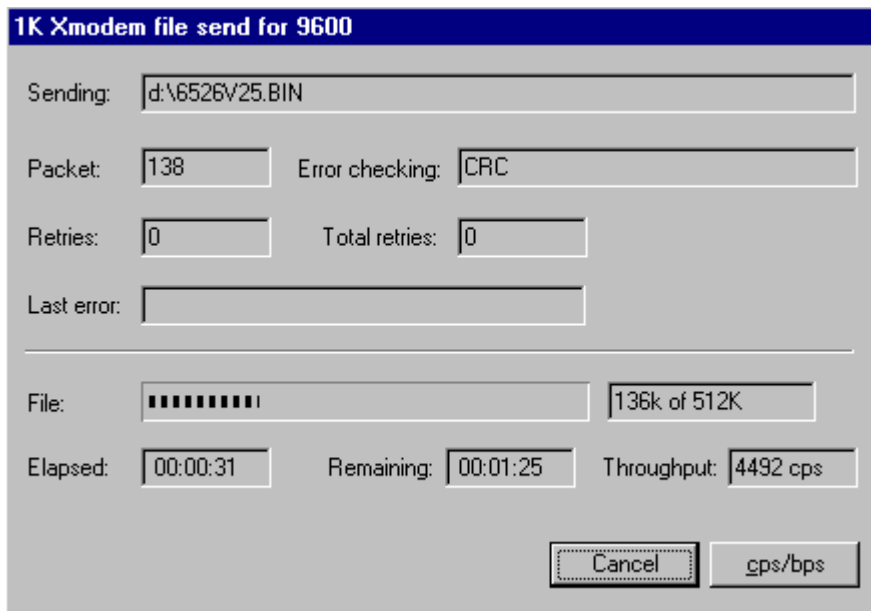

5. Finish download image, the switch system will update firmware automatic. Update firmware ok, the switch will reboot. Please change the boudrate to 9600bps.

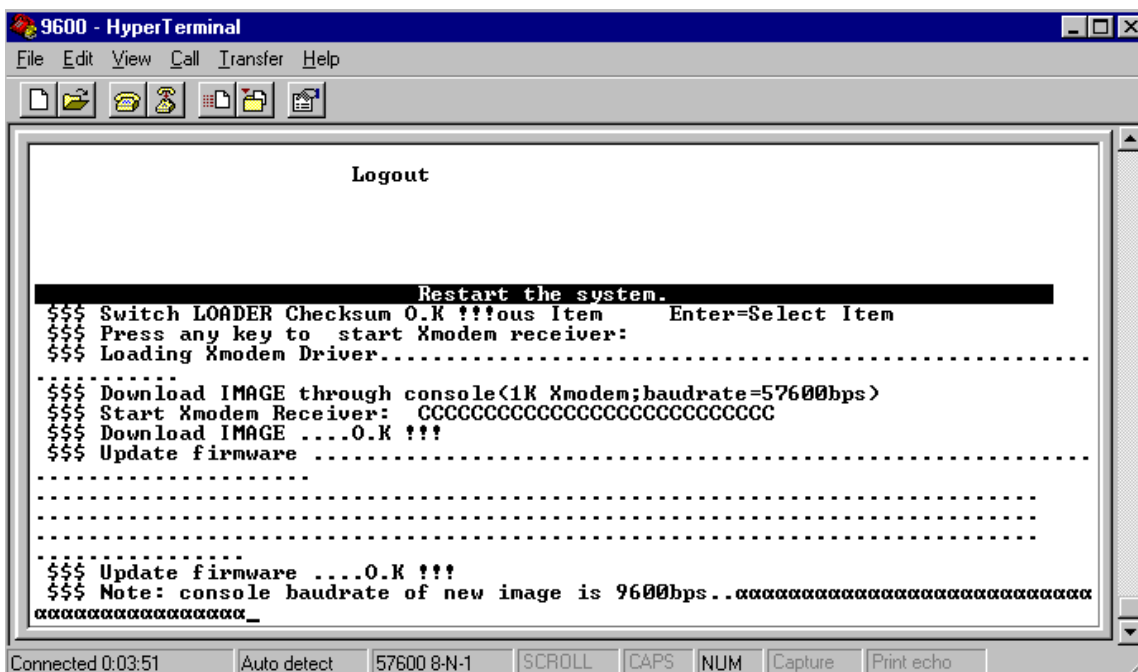

4. Out-of-band Terminal mode management

1. **24+2G switch** also provide a serial interface to manage and monitor the switch, user can follow the Console Port Information provide by web to use windows HyperTerminal program to link the switch.
2. You can type user name and password to login. The default user name is “**admin**”; the default password is “**123**”.

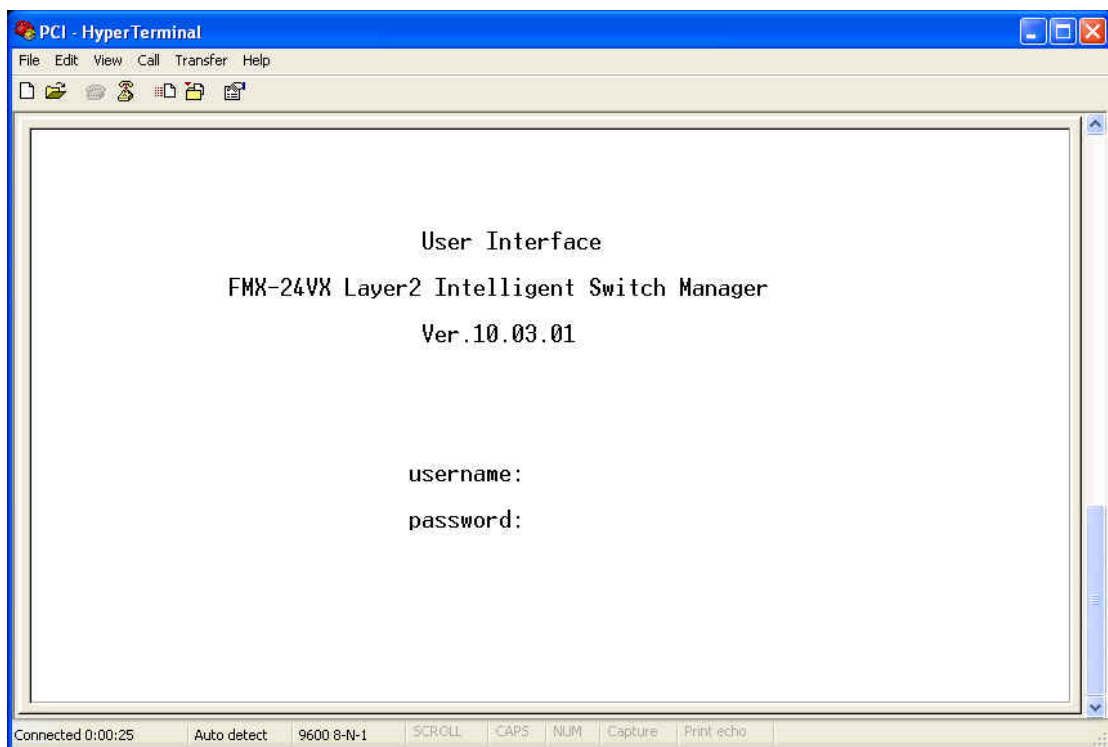

4.2 Switch Static Configuration

```
Intelligent Switch : Switch Configuration
=====
Port Configuration
Trunk Configuration
VLAN Configuration
Misc Configuration
Administration Configuration
Port Mirroring Configuration
Priority Configuration
MAC Address Configuration
Main Menu

Display or change port configuration.
Arrow/TAB/BKSPC = Move Item      Enter = Select Item
```

<Control Key>

You can press the key of **Tab** or **Backspace** to choose item, and press **Enter** key to select item. The action menu line as follow provided in later configure page.

Actions->

<Quit>: Exit the page of port configuration and return to previous menu.

<Edit>: Configure all items. Finished configure press

Ctrl+A: Back to action menu line.

<Save>: Save all configure value.

<Previous Page>: Return to previous page to configure.

<Next page>: Go to the next page to configure it.

4.2.1. Port Configuration

This page can change every port status.

Press **Space** key to change configures of per item.

Intelligent Switch : Port Configuration									
Port	Type	InRate (100K)	OutRate (100K)	Enable	Auto	Spd/Dpx		FlowControl	
								Full	Half
PORT1	100T _x	0	0	Yes	AUTO	100	Full	0n	0n
PORT2	100T _x	0	0	Yes	AUTO	100	Full	0n	0n
PORT3	100T _x	0	0	Yes	AUTO	100	Full	0n	0n
PORT4	100T _x	0	0	Yes	AUTO	100	Full	0n	0n
PORT5	100T _x	0	0	Yes	AUTO	100	Full	0n	0n
PORT6	100T _x	0	0	Yes	AUTO	100	Full	0n	0n
PORT7	100T _x	0	0	Yes	AUTO	100	Full	0n	0n
PORT8	100T _x	0	0	Yes	AUTO	100	Full	0n	0n

actions-> **<Quit>** <Edit> <Save> <Previous Page> <Next Page>

Select the Action menu.

Arrow/TAB/BKSPC = Move Item Quit = Previous menu Enter = Select Item

1. InRate (100K/unit):

User can set input rate control, per unit is 100K. The valid range is 0~1000.

0: disable rate control.

1~1000: valid rate value.

2. OutRate (100K/unit):

User can set output rate control, per unit is 100K. The valid range is 0~1000.

0: disable rate control.

1~1000: valid rate value.

3. Enabled:

User can **disable** or **enable** this port control.

“Yes” that mean the port is enable.

“No” that mean the port is disable.

4. Auto:

User can set auto negotiation mode is “**Auto**”, “**Nway_Force**”, “**Force**” of per port.

5. Spd/Dpx:

User can set “**100Mbps**” or “**10Mbps**” speed on port 1~port 24,

Set “**1000Mbps**”, “**100Mbps**” or “**10Mbps**” speed on port25~port26 (depend on module card mode), and set “**full-duplex**” or “**half-duplex**” mode.

6. Flow Control:

Full: User can set full flow control function ([pause](#)) as enable or disable.

Half: User can set half flow control function ([backpressure](#)) as enable or disable.

NOTE:

1. Pressing <Save> only can save one page configuration.
2. If the static trunk groups exist, you can see it (ex: TRK1, TRK2...) after port 26, and you can configure all of the items as above.

4.2.2. Trunk Configuration

This page can create max seven trunk groups. User can arbitrarily select up to four ports from port 1~port 26 to build a trunk group.

```

Intelligent Switch : Trunk Configuration
=====
 01 02 03 04 05 06 07 08 09 10 11 12 13 14 15 16 17 18 19 20 21 22 23 24 M1 M2
1 - - - - - - v v v v - - - - - v v v - - - - -
2 - - - - - - - - - - - - - v v v v - - - - -
3 - - - - - - - - - - - - - - - - - - - - - - -
4 - - - - - - - - - - - - - - - - - - - - - - -
5 - - - - - - - - - - - - - - - - - - - - - - -
6 - - - - - - - - - - - - - - - - - - - - - - -
7 - - - - - - - - - - - - - - - - - - - v - v - -

TRK1 Static
TRK2 LACP
TRK3 Disable
TRK4 Disable
TRK5 Disable
TRK6 Disable
TRK7 Static

actions->      <Edit>          <Save>          <Quit>
Select the action menu.
Arrow/TAB/BKSPC = Move Item  Quit = Previous menu  Enter = Select Item
  
```

Actions->

1. Select <Edit> on actions menu
2. Press **space** key to configure the member port of trunk group. Besides, you have to set “Static” or “LACP” for the corresponding trunk group of TRK1~TRK7 item.
 “Static” – the normal trunk.
 “LACP” – this trunk group have link aggregation control protocol.
3. Press **Ctrl+A** to go back action menu line
4. Select <Save> to save all configure value.
5. If the item of TRK1~TRK7 is set “Disable”, it’s mean the trunk group is deleted.
6. All ports in the same static trunk group will be treated as single port. So when you setting VLAN members and Port configuration they will be toggled on or off simultaneously.

NOTE: If VLAN group exist, all of the members of static trunk group **must** be in same VLAN group.

4.2.3. VLAN Configuration

```
Intelligent Switch : VLAN Configuration
=====

VLAN Configure
Create a VLAN Group
Edit/Delete a VLAN Group
Group Sorted Mode
Previous Menu

Configure the VLAN pvid and ingress, egress Rule.
Arrow/TAB/BKSPC = Move Item  Quit = Previous menu  Enter = Select Item
```

4.2.3.1. VLAN Configure

This page can set VLAN mode to port-based VLAN or 802.1Q VLAN or disable VLAN function.

```
Intelligent Switch : VLAN Support Configuraton
=====

VLAN Mode : PortBased

actions->  <Quit>      <Edit>      <Save>      <Previous Page>  <Next Page>
Select the Action menu.
Arrow/TAB/BKSPC = Move Item  Space = Toggle  Ctrl+A = Action menu
```

NOTE: Change the VLAN mode for every time, user have to restart the switch for valid value.

If set 802.1Q VLAN, you can set PVID, ingress filtering 1 and ingress filtering 2 in this page too.

```
Intelligent Switch : VLAN Support Configuraton
=====
VLAN Mode :802.1Q

Port      PVID      IngressFilter1      IngressFilter2
          PVID      NonMember Pkt      Untagged Pkt
-----
PORT1     1          Forward             Drop
PORT2     3          Forward             Forward
PORT3     1          Drop                Forward
PORT4     1          Drop                Forward
PORT5     1          Drop                Forward
PORT6     1          Drop                Forward
PORT7     1          Drop                Forward
PORT8     1          Drop                Forward

actions->  <Quit>    <Edit>    <Save>    <Previous Page>  <Next Page>
Select the Action menu.
Arrow/TAB/BKSPC = Move Item  Quit = Previous menu  Enter = Select Item
```

Actions->

1. PVID (Port VID: 1~255): Type the PVID.

2. NonMember Drop:

It matches that Ingress Filtering Rule 1 on web.

Forwarding only packets with VID matching this port's configured VID.

Press **Space** key to choose "forward" or "drop" the frame that VID not matching this port's configured VID.

3. UnTagged Drop:

It matches that Ingress Filtering Rule 2 on web.

Drop untagged frame.

Press **Space** key to choose "drop" or "forward" the untagged frame.

4.2.3.2. Create a VLAN Group

◆ Create Port-Based VLAN

Create a port-based VLAN and add member/nonmember ports to it.

1. Select **<Edit>**.
2. **VLAN Name:** Type a name for the new VLAN.
3. **Grp ID:** Type the VLAN group ID. The group ID rang is 1~4094.
4. **Member:** Press **<Space>** key to choose VLAN member. There are two types to selected:
 - a. **Member:** the port is member port.
 - b. **No:** the port is NOT member port.
5. Press **Ctrl+A** go back action menu line.
6. Select **<Save>** to save all configure value.

```

                                Add an VLAN Group
                                -----
VLAN Name: [vlan2          ] Grp ID: [2    ](1~4094)

Port      Member
-----
PORT1    Member
PORT2    Member
PORT3    No
PORT4    Member
PORT5    No
PORT6    No
PORT7    No
PORT8    No

actions->  <Quit>    <Edit>    <Save>    <Previous Page>    <Next Page>
                Select the Action menu.
Arrow/TAB/BKSPC = Move Item  Quit = Previous menu  Enter = Select Item

```

NOTE: If the trunk groups exist, you can see it (ex: TRK1, TRK2...) after port26, and you can configure it is the member of the VLAN or not.

◆ *Create 802.1Q VLAN*

Create an 802.1Q VLAN and add tagged /untagged member ports to it.

1. Select <Edit>.
2. **VLAN Name:** Type a name for the new VLAN.
3. **VLAN ID:** Type a VID (between 1~4094). The default is 1. There are 256 VLAN groups to provided configure.
4. **Protocol VLAN:** Press **Space** key to choose protocols type.
5. **Member:** Press **Space** key to choose VLAN member. There are three types to selected:
 - a. **UnTagged** : This port is the member port of this VLAN group and outgoing frames are NO VLAN-Tagged frames.
 - b. **Tagged** : This port is the member port of this VLAN group and outgoing frames are VLAN-Tagged frames.
 - c. **NO** : The port is NOT member of this VLAN group.
6. Press **Ctrl+A** go back action menu line.
7. Select <Save> to save all configure value.

```

                                Add an VLAN Group
                                -----
VLAN Name: [vlan2          ] VLAN ID: [2    ](1~4094)
Protocol VLAN : None
Port          Member
-----
PORT1        UnTagged
PORT2        Tagged
PORT3        UnTagged
PORT4        No
PORT5        No
PORT6        No
PORT7        No
PORT8        No

actions->    <Quit>    <Edit>    <Save>    <Previous Page>    <Next Page>
                Select the Action menu.
Arrow/TAB/BKSPC = Move Item    Quit = Previous menu    Enter = Select Item
  
```

NOTE: If the trunk groups exist, you can see it (ex: TRK1, TRK2...) after port 26, and you can configure it is the member of the VLAN or not.

4.2.3.3. Edit / Delete a VLAN Group

In this page, user can edit or delete a VLAN group.

1. Press **<Edit>** or **<Delete>** item.
2. Choose the VLAN group that you want to edit or delete and then press enter.
3. User can modify the protocol VLAN item and the member ports are tagged or un-tagged and remove some member ports from this VLAN group.
4. After edit VLAN, press **<Save>** key to save all configures value.

```

NAME:          VID:          NAME:          VID:
-----
DEFAULT        1
vlan2          2

actions-> <Quit> <Edit> <Delete> <Previous Page> <Next Page>
Edit/Delete a VLAN Group.
Arrow/TAB/BKSPC = Move Item  CTRL+A = Action menu  Enter = Select Item
  
```

```

Edit an VLAN Group
-----
VLAN Name: [vlan2          ] VLAN ID: [2          ](1~4094)
Protocol VLAN : None

Port          Member
-----
PORT1        UnTagged
PORT2        Tagged
PORT3        UnTagged
PORT4        No
PORT5        No
PORT6        No
PORT7        No
PORT8        No

actions-> <Quit> <Edit> <Save> <Previous Page> <Next Page>
Select the Action menu.
Arrow/TAB/BKSPC = Move Item  Quit = Previous menu  Enter = Select Item
  
```

NOTE :

1. When pressing **<Enter>** once will complete deletion on delete mode.
2. The VLAN Name and VLAN ID cannot modify.
3. The default VLAN can't be deleting.

4.2.3.4. Groups Sorted Mode

In this page, user can select VLAN groups sorted mode:

- (1) sorted by name
- (2) Sorted by VID.

The *Edit/Delete a VLAN group* page will display the result.

```

Intelligent Switch : Group Sorted Selection
=====

Group Sorted :Sorted_By_Name

actions->      <Edit>          <Save>          <Quit>
Select the action menu.
Arrow/TAB/BKSPC = Move Item  Quit = Previous menu  Enter = Select Item
  
```

In the *Edit/Delete a VLAN Group* page, the result of **sorted by name**.

```

NAME:          VID:          NAME:          VID:
-----
DEFAULT        1
A1             56
B1             33
vlan2         2

actions->      <Quit>      <Edit>      <Delete>      <Previous Page>      <Next Page>
Edit/Delete a VLAN Group.
Arrow/TAB/BKSPC = Move Item  Quit = Previous menu  Enter = Select Item
  
```

In the *Edit/Delete a VLAN Group* page, the result of **sorted by VID**.

NAME:	VID:	NAME:	VID:
-----	-----	-----	-----
DEFAULT	1		
vlan2	2		
B1	33		
A1	56		

actions-> **Quit** <Edit> <Delete> <Previous Page> <Next Page>
 Edit/Delete a VLAN Group.
 Arrow/TAB/BKSPC = Move Item Quit = Previous menu Enter = Select Item

4.2.4. Misc Configuration

Intelligent Switch : Misc Configuration =====	
Ping	
MAC Age Interval	
Broadcast Storm Filtering	
Max bridge transmit delay bound	
Port Security	
Collisions Retry Forever	
Hash Algorithm	
IFG Compensation	
Previous Menu	
Ping the device IP address.	
Arrow/TAB/BKSPC = Move Item	Enter = Select Item

4.2.4.1. Ping

```
Intelligent Switch : Ping
=====

IP Address   : 192.168.1.87
Send Counts  : 10
Reply Counts : 10

actions->      <Edit>          <Save>          <Quit>
Select the action menu.
Arrow/TAB/BKSPC = Move Item  Quit = Previous menu  Enter = Select Item
```

Type the Host IP and the counts for pinging, then back to action menu and press “Save”. “Reply Counts” will display the result of pinging.

4.2.4.2. MAC Age Interval

Type the number of seconds that an inactive MAC address remains in the switch’s address table. The valid range is 300~765 seconds. Default is **300** seconds.

```

Intelligent Switch : MAC Aging Time
=====

MAC Age Interval (sec) [300] : 300
(disable:0,valid value:300~765)

actions->      <Edit>          <Save>          <Quit>
Select the action menu.
Arrow/TAB/BKSPC = Move Item  Quit = Previous menu  Enter = Select Item

```

4.2.4.3. Broadcast Storm Filtering

This page is configuring broadcast storm control.

1. Press **<Edit>** to configure the broadcast storm filter mode.
2. Press **Space** key to choose the threshold value.

The valid threshold value is 5%, 10%, 15%, 20%, 25% and NO. Default is **5%**.

```

Intelligent Switch : Broadcast Storm Filter Mode
=====

Broadcast Storm Filter Mode :5

actions->      <Edit>          <Save>          <Quit>
Select the action menu.
Arrow/TAB/BKSPC = Move Item  Quit = Previous menu  Enter = Select Item

```

4.2.4.4. Max bridge transmit delay bound

- 1. Max bridge transmit delay bound:** Limit the packets queuing time in switch. If enabled, the packets queued exceed will be drop. Press **Space** key to set the time. Those valid values are 1sec, 2sec, and 4sec and off. Default is **off**.
- 2. Low Queue Delay Bound:** Limit the low priority packets queuing time in switch. If enabled, the low priority packet stays in switch exceed Low Queue Max Delay Time, it will be sent. Press **Space** key to enable or disable this function. Default is **disable**.
- 3. Low Queue Max Delay Time:** To set the time that low priority packets queuing in switch. The valid range is 1~255ms. Default Max Delay Time is **255**ms.

```
Intelligent Switch : Max Bridge Transmit Delay Bound
=====

Max bridge transmit delay bound :OFF
Low Queue Delay Bound :Disabled
Low Queue Max Delay Time :255 (2ms/unit)

actions->      <Edit>          <Save>          <Quit>
Select the action menu.
Arrow/TAB/BKSPC = Move Item  Quit = Previous menu  Enter = Select Item
```

NOTE: Make sure “Max bridge transit delay bound control” is enabled before enabling Low Queue Delay Bound, because Low Queue Delay Bound must be work under “Max bridge transit delay bound control” is enabled situation.

4.2.4.5. Port Security

A port in security mode will be “locked” without permission of address learning. Only the incoming packets with SMAC already existing in the address table can be forwarded normally. User can disable the port from learning any new MAC addresses, then use the static MAC addresses screen to define a list of MAC addresses that can use the secure port.

```

Intelligent Switch : Port Security
=====

Port          Enable Security
              (disable for MAC Learning)
-----
PORT1         Enabled
PORT2         Enabled
PORT3         Enabled
PORT4         Disabled
PORT5         Disabled
PORT6         Disabled
PORT7         Disabled
PORT8         Disabled

actions->    <Quit>      <Edit>      <Save>      <Previous Page>  <Next Page>
              Select the Action menu.
Arrow/TAB/BKSPC = Move Item  Quit = Previous menu  Enter = Select Item

```

Actions->

1. Select <Edit>.
2. Press **Space** key to choose enable / disable item.
3. Press **Ctrl+A** to go back action menu line.
4. Select <Save> to save all configure value.
5. You can press <Next Page> to configure port9 ~ port26, press <Previous Page> return to last page.

4.2.4.5. Collisions Retry Forever

Collisions Retry Forever: **Disable** – In half duplex, if happen collision will retry 48 times and then drop frame.
Enable – In half duplex, if happen collision will retry forever (Default).

```
Intelligent Switch : Collisions Retry Forever
=====

Collisions Retry Forever : Enabled

actions->      <Edit>          <Save>          <Quit>
Select the action menu.
Arrow/TAB/BKSPC = Move Item  Quit = Previous menu  Enter = Select Item
```

4.2.4.6. Hash Algorithm

Select CRC-Hash(default) or DirectMap for Hash algorithm.

```
Intelligent Switch : Hash Algorithm
=====

Hash Algorithm : CRC-Hash

actions->      <Edit>          <Save>          <Quit>
Select the action menu.
Arrow/TAB/BKSPC = Move Item  Quit = Previous menu  Enter = Select Item
```

4.2.4.7. IFG Compensation

Enable or disable the inter-frame gap (IFG) compensation function.

Intelligent Switch : IFG Compensation
=====

IFG Compensation : Enabled

actions-> <Edit> <Save> <Quit>

Select the action menu.

Arrow/TAB/BKSPC = Move Item Quit = Previous menu Enter = Select Item

4.2.5. Administration Configuration

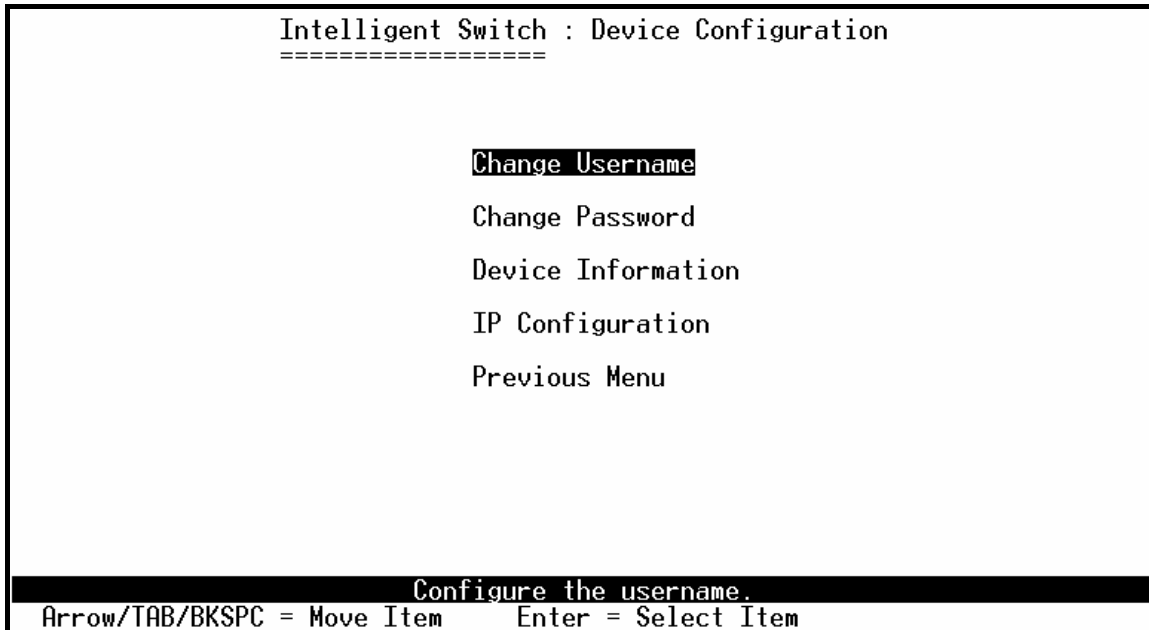

4.2.5.1. Change Username

Use this page; user can change web management user name.

Type the new user name, and then press <Save> item.

```
Intelligent Switch : UserName Configuration
=====

UserName : admin

actions->      <Edit>          <Save>          <Quit>
Select the action menu.
Arrow/TAB/BKSPC = Move Item  Quit = Previous menu  Enter = Select Item
```

4.2.5.2. Change Password

Use this page; user can change web management login password.

```
Intelligent Switch : Password Configuration
=====

Old Password : *****
New Password : *****
Enter Again  : *****

actions->      <Edit>          <Save>          <Quit>
Select the action menu.
Arrow/TAB/BKSPC = Move Item  Quit = Previous menu  Enter = Select Item
```

4.2.5.3. Device Information

This page is provided to the user to configure the device information.

```

Intelligent Switch : Device Information
=====

Name      :      Layer 2 Intelligent Switch
Contact   :      Admin
Location  :
Description :      24+2G Layer 2 Intelligent SNMP Switch

actions->      <Edit>          <Save>          <Quit>
Select the action menu.
Arrow/TAB/BKSPC = Move Item  Quit = Previous menu  Enter = Select Item

```

4.2.5.4. IP Configuration

User can configure the IP setting and fill in the new value.

```

Intelligent Switch : IP Configuration
=====

DHCP      : Disabled
Switch IP : 192.168.223.100
Switch netmask: 255.255.255.0
Gateway   : 192.168.223.254
Management Mode : Stacking Master
Agent IP   : 192.168.5.100
Agent netmask : 255.255.255.0

actions->      <Edit>          <Save>          <Quit>
Select the action menu.
Arrow/TAB/BKSPC = Move Item  Space = Toggle  Ctrl+A = Action menu

```

4.2.6. Port Mirror Configuration

The port mirroring is a method for monitor traffic in switched networks. Traffic through ports can be monitored by one specific port. That is traffic goes in or out monitored ports will be duplicated into monitoring port.

Actions->

Press **Space** key to change configure of per item.

1. Select **<Edit>**.
2. **Sniffer Mode:** Press **Space** key to set sniffer mode Disable 、 Rx 、 Tx or Both.
3. **Monitoring Port:** It means sniffer port can be used to see all monitors port traffic. Press **Space** key to choose it.
4. **Monitored Port:** The ports you want to monitor. All monitor port traffic will be copied to sniffer port. You can select max 25 monitor ports in the switch. User can choose which port to monitor in only one sniffer mode. Press **Space** key to choose member port, “V” – is the member, “—” – not the member.
5. Press **Ctrl+A** go back action menu line
6. Select **<Save>** to save all configure value.
7. On the action menu line you can press **<Next Page>** to configure port9 ~ port26, press **<Previous Page>** return to last page.

```
Intelligent Switch : Port Sniffer
=====

Sniffer Mode: Rx
Monitoring Port : PORT1
Monitored Port :

Port      member
-----
PORT1     -
PORT2     v
PORT3     -
PORT4     v
PORT5     -
PORT6     -
PORT7     v
PORT8     -

actions->  <Quit>   <Edit>   <Save>   <Previous Page>   <Next Page>
Select the Action menu.
Arrow/TAB/BKSPC = Move Item  Quit = Previous menu  Enter = Select Item
```

NOTE: Only has one sniffer mode in switch at the same time.

4.2.7. Priority Configuration

```
Intelligent Switch : The Priority configuration
=====

Port Static Priority
802.1p priority
Previous Menu

Configure port static priority.
Arrow/TAB/BKSPC = Move Item   Enter = Select Item
```

4.2.7.1. Port Static Priority

This static priority based on port, if you set the port is high priority, income frame from this port always high priority frame.

```
Intelligent Switch : Port Priority
=====

Port          Priority
-----
PORT1         Low
PORT2         High
PORT3         Low
PORT4         High
PORT5         High
PORT6         Low
PORT7         High
PORT8         Low

actions->   <Quit>   <Edit>   <Save>   <Previous Page>   <Next Page>
Select the Action menu.
Arrow/TAB/BKSPC = Move Item   Quit = Previous menu   Enter = Select Item
```

4.2.7.2. 802.1p Priority Configuration

There are 0~7-priority level can map to high or low queue.

Actions->

1. Select **<Edit>**.
2. Press **Space** key to select the priority level mapping to high or low queue.
3. **High/Low Queue Service Ration H : L:** User can select the ratio of high priority packets and low priority packets.
4. Press **Ctrl+A** go back action menu line.
5. Select **<Save>** to save all configure value.

```
Intelligent Switch : 802.1p Priority Configuration
=====
      Will be overwritten by port-priority!!

Priority 0   : Low
Priority 1   : Low
Priority 2   : Low
Priority 3   : Low
Priority 4   : High
Priority 5   : High
Priority 6   : High
Priority 7   : High

QosMode : High/Low Queue Service Ratio
=> H:[2] L:[1]

actions->      <Edit>          <Save>          <Quit>
Select the action menu.
Arrow/TAB/BKSPC = Move Item  Quit = Previous menu  Enter = Select Item
```

4.2.8. MAC Address Configuration

```
Intelligent Switch : MAC Address Configuration
=====

Static MAC Address
Filtering MAC Address
Previous Menu

Configure the MAC address.
Arrow/TAB/BKSPC = Move Item   Enter = Select Item
```

4.2.8.1. Static MAC Address

When you add a static MAC address, it remains in the switch's address table, regardless of whether the device is physically connected to the switch. This saves the switch from having to re-learn a device's MAC address when the disconnected or powered-off device is active on the network again. In this page user can add / modify / delete a static MAC address.

```
Intelligent Switch : Static MAC Address Configuration
=====

Mac Address   Port num  Vlan ID           Mac Address   Port num  Vlan ID
-----

actions->  <Quit>  <Add>  <Edit>  <Delete>  <Previous Page>  <Next Page>
Add/Edit/Delete a Mac.
Arrow/TAB/BKSPC = Move Item   Quit = Previous menu   Enter = Select Item
```

●Add static MAC address

Actions->

1. Press <Add> --> <Edit> key to add static MAC address.
2. **MAC Address:** Enter the MAC address to and from which the port should permanently forward traffic, regardless of the device’s network activity.
3. **Port num:** press <Space> key to select the port number.
4. **Vlan ID:** If tag-based (802.1Q) VLAN are set up on the switch, static addresses are associated with individual VLANs. Type the VID to associate with the MAC address.
5. Press **Ctrl+A** to go back action menu line.
6. Then select <Save> to save all configure value.

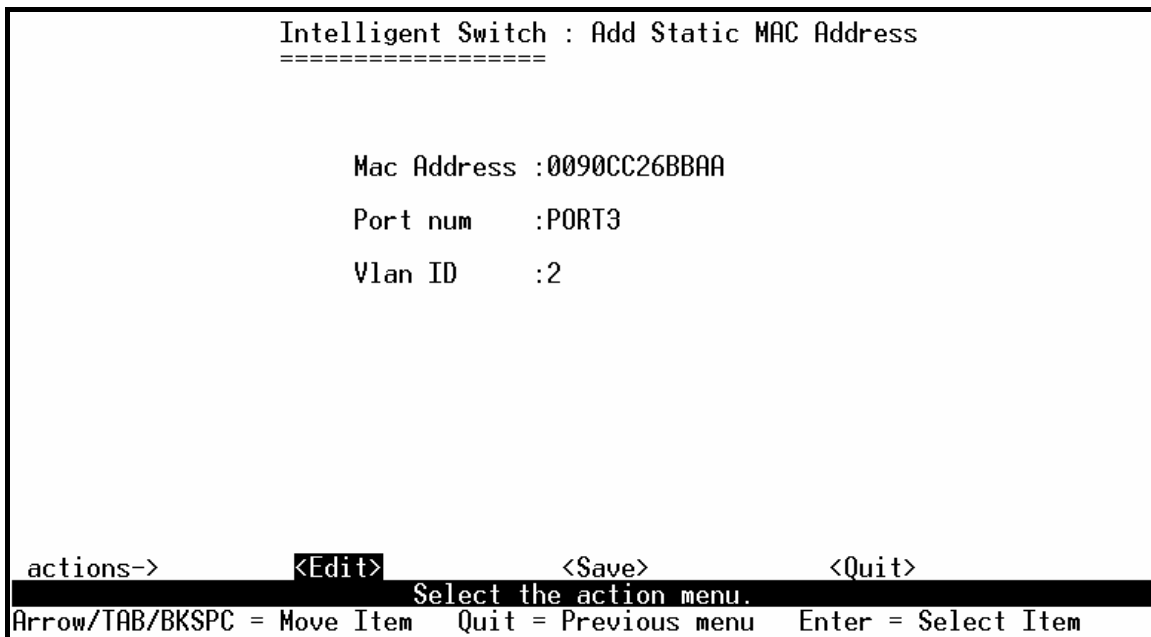

●Edit static MAC address

Actions->

1. Press <Edit> key.
2. Choose the MAC address that you want to modify and then press enter.

```

Intelligent Switch : Static MAC Address Configuration
=====
Mac Address      Port num  Vlan ID      Mac Address      Port num  Vlan ID
-----
0090CC26BBAA    PORT3     2
005000100001    PORT10    4

actions->  <Quit>  <Add>  <Edit>  <Delete>  <Previous Page>  <Next Page>
Add/Edit/Delete a Mac.
Arrow/TAB/BKSPC = Move Item  Quit = Previous menu  Enter = Select Item

```

3. Press **<Edit>** key to modify all the items.
4. Press **Ctrl +A** to go back action menu line, and then select **<Save>** to save all configure value.

```

Intelligent Switch : Static MAC Address Configuration
=====

Mac Address : 0090CC26BBAA
Port num    : PORT3
Vlan ID     : 2

actions->      <Edit>      <Save>      <Quit>
Select the action menu.
Arrow/TAB/BKSPC = Move Item  Space = Toggle  Ctrl+A = Action menu

```

●Delete static MAC address

Actions->

1. Press **<Delete>** key.
2. Choose the MAC address that you want to delete and then press enter.
3. Pressing **<Enter>** once will complete deletion on delete mode.

Intelligent Switch : Static MAC Address Configuration

=====

Mac Address	Port num	Vlan ID	Mac Address	Port num	Vlan ID
0090CC26BBAA	PORT3	2			
005000100001	PORT10	4			

actions-> <Quit> <Add> <Edit> **<Delete>** <Previous Page> <Next Page>
Add/Edit/Delete a Mac.
Arrow/TAB/BKSPC = Move Item Quit = Previous menu Enter = Select Item

4.2.8.2. Filtering MAC Address

MAC address filtering allows the switch to drop unwanted traffic. Traffic is filtered based on the destination addresses.

In this page user can add /modify /delete filter MAC address.

```
Intelligent Switch : Filter MAC Address Configuration
=====
Mac Address      Vlan ID          Mac Address      Vlan ID
-----

```

```
actions-> <Quit> <Add> <Edit> <Delete> <Previous Page> <Next Page>
Add/Edit/Delete a Mac.
Arrow/TAB/BKSPC = Move Item   Quit = Previous menu   Enter = Select Item
```

● Add filter MAC address

Actions->

1. Press <Add> --> <Edit> key to add a filter MAC address.
2. **MAC Address:** Type the MAC address to filter.
3. **Vlan ID:** If tag-based (802.1Q) VLAN are set up on the switch, type the VID to associate with the MAC address.
4. Press **Ctrl+A** to go back action menu line, and then select <Save> to save all configure value.

```

Intelligent Switch : Add Filter MAC Address
=====

Mac Address : 000000001A01
Vlan ID     : 2

actions->      <Edit>          <Save>          <Quit>
Save successfully!press any key to return!
Arrow/TAB/BKSPC = Move Item  Quit = Previous menu  Enter = Select Item

```

●Edit filter MAC address

Actions->

1. Press <Edit> key.
2. Choose the MAC address that you want to modify and then press enter.

```

Intelligent Switch : Filter MAC Address Configuration
=====

Mac Address  Vlan ID          Mac Address  Vlan ID
-----
000000000001  1
000000000002  2
000000000003  3

actions->  <Quit>  <Add>  <Edit>  <Delete>  <Previous Page>  <Next Page>
Add/Edit/Delete a Mac.
Arrow/TAB/BKSPC = Move Item  Space = Toggle  Ctrl+A = Action menu

```

3. Press <Edit> key to modify all the items.
4. Press **Ctrl+A** to go back action menu line, and then select <Save> to save all configure value.

Intelligent Switch : Edit Filter MAC Address
=====

Mac Address :000000000001

Vlan ID :1

actions-> <Edit> <Save> <Quit>

Can not modify for Read Only item.

Arrow/TAB/BKSPC = Move Item Space = Toggle Ctrl+A = Action menu

●Delete filter MAC address

Actions->

1. Press <Delete> key to delete a filter MAC address.
2. Choose the MAC address that you want to delete and then press enter.
3. When pressing <Enter> once will complete deletion on delete mode.

```
Intelligent Switch : Filter MAC Address Configuration
=====
Mac Address      Vlan ID          Mac Address      Vlan ID
-----
0000000000001   1
0000000000002   2
0000000000003   3

actions-> <Quit> <Add> <Edit> <Delete> <Previous Page> <Next Page>
Add/Edit/Delete a Mac.
Arrow/TAB/BKSPC = Move Item  Quit = Previous menu  Enter = Select Item
```

4.3. Protocol Related Configuration

```
Intelligent Switch : The Protocol Related configuration
=====

  STP
  SNMP
  GVRP
  IGMP
  LACP
  802.1X
  Previous Menu

Configure the Spanning Tree Protocol.
Arrow/TAB/BKSPC = Move Item      Enter = Select Item
```

4.3.1. STP

The Spanning-Tree Protocol (STP) is a standardized method (IEEE 802.1D) for avoiding loops in switched networks. When STP enabled, to ensure that only one path at a time is active between any two nodes on the network.

```
Intelligent Switch : Spanning Tree Protocol
=====

  Enable/Disable STP
  System Configuration
  Perport Configuration
  Previous Menu

Enabled or disabled the Spanning Tree Protocol.
Arrow/TAB/BKSPC = Move Item      Enter = Select Item
```

4.3.1.1. Enable/Disable STP

This page is showing the users how to enable or disable Spanning Tree function. Press **Space** key to select enable or disable.

```
Intelligent Switch : STP Enabled/Disabled Configuration
=====

STP :Enabled

actions->      <Edit>          <Save>          <Quit>
Select the action menu.
Arrow/TAB/BKSPC = Move Item  Quit = Previous menu  Enter = Select Item
```

4.3.1.2. STP System Configuration

```
Intelligent Switch : STP System Configuration
=====

Root Bridge Information          Configure Spanning Tree Parameters
-----
Priority       : 32768           Priority (0-65535) :32768
Mac Address   : 00055D102140
Root_Path_Cost: 20              Max Age (6-40)    :20
Root Port    : PORT4           Hello Time (1-10) :2
Max Age      : 20
Hello Time   : 2
Forward Delay: 15              Forward_Delay_Time(4-30) :15

actions->      <Edit>          <Save>          <Quit>
Select the action menu.
Arrow/TAB/BKSPC = Move Item  Quit = Previous menu  Enter = Select Item
```

Actions->

1. You can view spanning tree information about the Root Bridge on the left.
2. On the right, user can set new value for STP parameter.

NOTE: All about the parameter description please see the [sections 2-4-8](#).

4.3.1.3. Perport Configuration

Intelligent Switch : STP Port Configuration			
Port	PortState	PathCost	Priority
PORT1	Forwarding	10	128
PORT2	Forwarding	10	128
PORT3	Forwarding	10	128
PORT4	Forwarding	10	128
PORT5	Forwarding	10	128
PORT6	Forwarding	10	128
PORT7	Forwarding	10	128
PORT8	Forwarding	10	128

actions-> <Quit> <Edit> <Save> <Previous Page> <Next Page>
Select the Action menu.
Arrow/TAB/BKSPC = Move Item CTRL+A = Action menu Enter = Select Item

Actions->

1. **PortState:** Display spanning tree status about the switch for per port is forwarding or blocking.
2. Select <Edit>.
3. **PathCost:** Specifies the path cost of the port that switch uses to determine which port are the forwarding ports.
4. **Priority:** This means priority port, you can make it more or less likely to become the root port.
5. Press **Ctrl +A** back to action menu line.
6. Select <Save> to save all configure value.
7. On the action menu line you can press <Next Page> to configure port9 ~ port26, press <Previous Page> return to last page.

NOTE: All about the parameter description please see the [sections 2-4-8](#).

4.3.2. SNMP

Any Network Management running the simple Network Management Protocol (SNMP) can be management the switch.

Use this page to define management stations as trap managers and to enter SNMP community strings. User can also define a name, location, and contact person for the switch.

```
Intelligent Switch : SNMP Configuration
=====

System Options
Community Strings
Trap Managers
Previous Menu

Configure the system information.
Arrow/TAB/BKSPC = Move Item   Enter = Select Item
```

4.3.2.1. System Options

```
Intelligent Switch : System Options Configuration
=====

System Name :      Layer 2 Intelligent Switch
System Contact :   Admin
System Location :
System Description : 24+2G Layer 2 Intelligent SNMP Switch

actions->          <Edit>                <Save>                <Quit>
Select the action menu.
Arrow/TAB/BKSPC = Move Item  Quit = Previous menu  Enter = Select Item
```

Actions->

1. Press **<Edit>**.
2. **System Name:** Type a name to be used for the switch.
3. **System Contact:** Type the name of contact person or organization.
4. **System Location:** Type the location of the switch.
5. **System Description:** Type the description about the switch.
6. Press **Ctrl+A** go back action menu line.
7. Press **<Save>** to save the configure value.

4.3.2.2. Community Strings

Use this page to Add/ Edit/ Delete SNMP community strings.

1. **Community Name:** The name of current strings.

2. **Write Access:** Enable the rights is read only or read-write.

Restricted: Read only, enables requests accompanied by this string to display MIB-object information.

Unrestricted: Read write, enables requests accompanied by this string to display MIB-object information and to set MIB objects.

```
Intelligent Switch : SNMP Community Configuration
=====
Community Name      Write Access
-----
public              Restricted
private             Unrestricted

actions->          <Add>          <Edit>          <Delete>          <Quit>
Add/Edit/Delete community strings.
Arrow/TAB/BKSPC = Move Item  CTRL+A = Action menu  Enter = Select Item
```

● **Add Community Name**

1. Press **<Add>** --> **<Edit>** key.
2. **Community Name:** Type the community name.
3. **Write Access:** Press **Space** key to select the right is restricted or unrestricted.

```
Intelligent Switch : Add SNMP Community
=====

Community Name :Command1
Write Access   :Restricted

actions->      <Edit>          <Save>          <Quit>
Select the action menu.
Arrow/TAB/BKSPC = Move Item  Space = Toggle  Ctrl+A = Action menu
```

● **Edit Community Name**

1. Press **<Edit>** key, choose the item that you want to modify and then press **Enter**.
2. **Community Name:** Type the new name.
3. **Write Access:** Press **<Space>** key to change the right is restricted or unrestricted.

```
Intelligent Switch : Edit SNMP Community
=====

Community Name :public
Write Access   :Restricted

actions->      <Edit>          <Save>          <Quit>
Select the action menu.
Arrow/TAB/BKSPC = Move Item  Quit = Previous menu  Enter = Select Item
```

● **Delete Community Name**

1. Press <Delete> key.
2. Choose the community name that you want to delete and then press enter.
3. When pressing <Enter> once will complete deletion on delete mode.

```
Intelligent Switch : SNMP Community Configuration
=====
Community Name      Write Access
-----
public              Restricted
private             Unrestricted
Command1            Restricted

actions->          <Add>          <Edit>          <Delete>          <Quit>
Delete SNMP community strings.
Arrow/TAB/BKSPC = Move Item  CTRL+A = Action menu  Enter = Select Item
```

4.3.2.3. Trap Managers

A trap manager is a management station that receives traps, the system alerts generated by the switch. If no trap manager is defined, no traps are issued. Create a trap manager by entering the IP address of the station and a community string.

```
Intelligent Switch : Trap Managers Configuration
=====
IP
-----
Community Name

actions->      <Add>          <Edit>          <Delete>       <Quit>
Add/Edit/Delete trap managers.
Arrow/TAB/BKSPC = Move Item  Quit = Previous menu  Enter = Select Item
```

- **Add SNMP trap manager**

1. Press <Add> --> <Edit> to add the trap manager.
2. **IP:** Type the IP address.
3. **Community Name:** Type the community name.
4. Press **Ctrl +A** go to actions line, press <Save> key to save all configure.

```
Intelligent Switch : Add SNMP Trap Manager
=====

IP :192.168.1.131
Community Name :public

actions->      <Edit>          <Save>          <Quit>
Select the action menu.
Arrow/TAB/BKSPC = Move Item  CTRL+A = Action menu  Enter = Select Item
```

- **Edit trap managers**

1. Press <Edit> key, and then choose the item that you want to modify.
2. **IP:** Type the new IP address
3. **Community Name:** Type the community name.
4. Press **Ctrl +A** go to actions line, press <Save> key to save all configure.

```

Intelligent Switch : Edit Trap Managers
=====

IP :192.168.1.131
Community Name :public

actions->      <Edit>          <Save>          <Quit>
Select the action menu.
Arrow/TAB/BKSPC = Move Item  Quit = Previous menu  Enter = Select Item
  
```

- **Delete trap manager**

1. Press <Delete> key.
2. Choose the trap manager that you want to delete and then press enter.
3. When pressing <Enter> once will complete deletion on delete mode.

```

Intelligent Switch : Trap Managers Configuration
=====

IP          Community Name
-----
192.168.1.131  public

actions->      <Add>          <Edit>          <Delete>          <Quit>
Delete SNMP trap managers.
Arrow/TAB/BKSPC = Move Item  Quit = Previous menu  Enter = Select Item
  
```

4.3.3. GVRP

GVRP (GARP [Generic Attribute Registration Protocol] VLAN Registration Protocol)

GVRP allows automatic VLAN configuration between the switch and nodes.

For example, if the switch is connected to a device with GVRP enabled, you can enable this setting to allow dynamic VLAN configuration information to be processed by the switch.

If a device sends a GVRP request using the VID of a VLAN defined on the switch, the switch will automatically add that device to the existing VLAN.

This page you can enable / disable the GVRP (GARP VLAN Registration Protocol) support.

```
Intelligent Switch : GVRP Configuration
=====

GVRP : Enabled

actions->          <Edit>          <Save>          <Quit>
Select the action menu.
Arrow/TAB/BKSPC = Move Item  Space = Toggle  Ctrl+A = Action menu
```

Actions->

1. Select <Edit>.
2. Press **Space** key to choose Enabled / Disabled.
3. Press **Ctrl+A** back to action menu line.
4. Select <Save> to save configure value.

Note: GVRP must also be enabled on participating network nodes.

4.3.4. IGMP

The Internet Group Management Protocol (IGMP) is an internal protocol of the Internet Protocol (IP) suite.

This page you can enable / disable the IGMP support.

```
Intelligent Switch : IGMP Configuration
=====

IGMP Protocol    : Enable
IGMP Query Mode : Auto

actions->      <Edit>          <Save>          <Quit>
Select the action menu.
Arrow/TAB/BKSPC = Move Item  Space = Toggle  Ctrl+A = Action menu
```

Actions->

1. Select <Edit>.
2. **IGMP Protocol:** Press **Space** key to choose Enable / Disable.
3. **IGMP Query Mode:** Press **Space** key to choose Auto / Enable /Disable.
4. Press **Ctrl+A** go back action menu line.
5. Select <Save> to save configure value.

4.3.5. LACP (Link Aggregation Control Protocol)

This page can configure and view all the LACP status.

```
Intelligent Switch : LACP Configuration
=====

Working Ports Setting

State Activity
LACP Status
Previous Menu

LACP setting.
Arrow/TAB/BKSPC = Move Item   Enter = Select Item
```

Note: All ports support LACP dynamic trunk group. If connecting to the device that also supports LACP, the LACP dynamic trunk group will be created automatically.

4.3.5.1. Working Port Setting

This page can set the actually work ports in trunk group.

```
Intelligent Switch : LACP Group Configuration
=====

Group      LACP Work Port Num
-----
TRK7      4

actions->   <Edit>           <Save>           <Quit>
Select the action menu.
Arrow/TAB/BKSPC = Move Item   Quit = Previous menu   Enter = Select Item
```

Actions->

1. Select <Edit>.
2. **Group:** Display the trunk group ID.
3. **LACP:** Display the trunk group's LACP status.
4. **LACP Work Port Num:** The max number of ports can be aggregated at the same time. If LACP static trunk group, the exceed ports is standby and able to aggregate if work ports fail. If local static trunk group, the number must be the same as group ports.

NOTE: Before set this page, you have to set trunk group on the page of *Trunk Configuration* first.

4.3.5.2. State Activity

```
Intelligent Switch : LACP Port State Active Configuration
=====

Port          State Activity          Port          State Activity
-----
21            Active
22            Active
23            Active
24            Active

actions->      <Edit>                <Save>         <Quit>
Select the action menu.
Arrow/TAB/BKSPC = Move Item  Quit = Previous menu  Enter = Select Item
```

Actions->

1. Select <Edit>.
2. Press **Space** key to choose the item.
Active: The port automatically sends LACP protocol packets.
Passive: The port does not automatically send LACP protocol packets, and responds only if it receives LACP protocol packets from the opposite device.
3. Press **Ctrl+A** go back action menu line.
4. Select <Save> to save configure value.

NOTE: If user set LACP mode in the trunk group, all of the member ports of this trunk group will set "Active" automatic.

4.3.5.3. LACP Status

When you're setting trunk group, you can see the relational information here.

Static trunk group

```
Intelligent Switch : LACP Group Status
=====

                Static Trunking Group

Group Key : 7

Port_No   : 21 22 23 24

actions->  <quit>    <Previous Page>    <Next Page>
                Select the action menu.
Arrow/TAB/BKSPC = Move Item   Quit = Previous menu   Enter = Select Item
```

LACP trunk group

```
Intelligent Switch : LACP Group Status
=====

                Group

                [Actor]                [Partner]

Priority:    1                1

MAC        :    000A17004567                000A17005678

Port_No  Key   Priority  Active  Port_No  Key   Priority
21       519   1       selected  24       519   1
22       519   1       selected  23       519   1
23       519   1       selected  22       519   1
24       519   1       selected  21       519   1

actions->  <quit>    <Previous Page>    <Next Page>
                Select the action menu.
Arrow/TAB/BKSPC = Move Item   Quit = Previous menu   Enter = Select Item
```

Actions->

<Quit>: Exit this page and return to previous menu.

<Previous Page>: Return to previous page to view.

<Next page>: Go to the next page to view.

4.3.6. 802.1x Protocol

This page can configure and view all the 802.1x status.

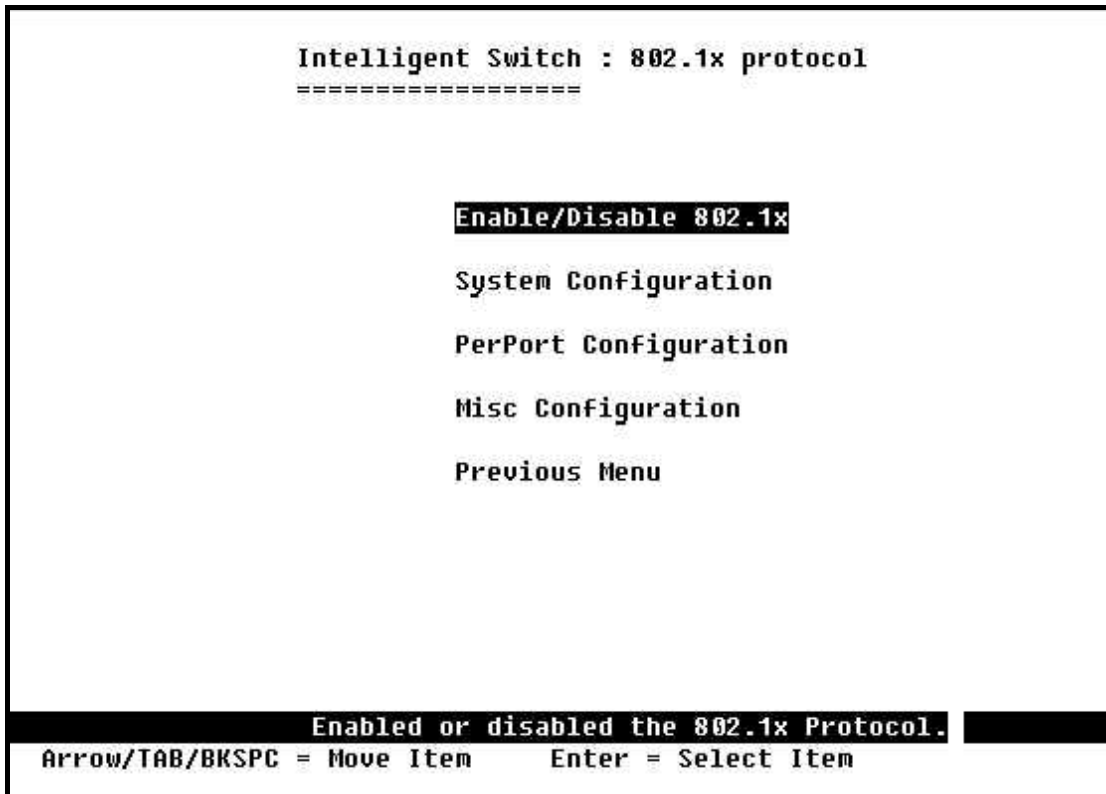

4.3.6.1. Enable/Disable 802.1x



1. Select **<Edit>**.
2. Press **Space** key to choose Enabled / Disabled.
3. Press **Ctrl+A** go back action menu line.
4. Select **<Save>** to save configure value.

4.3.6.2. 802.1x System Configuration

```
Intelligent Switch : 802.1x System Configuration
=====

Radius Server IP : 192.168.1.128
Shared Key : 12345678
NAS,Identifier: NAS_L2_SWITCH
Server Port: 1812
Accounting Port: 1813

actions->      <Edit>          <Save>          <Quit>
Select the action menu.
Arrow/TAB/BKSPC = Move Item  Quit = Previous menu  Enter = Select Item
```

1. Press <Edit>.
2. **Radius Server IP Address:** the IP address of the authentication server.
3. **Shared Key:** A key shared between this switch and authentication server.
4. **NAS, Identifier:** A string used to identify this switch.
5. **Server Port:** The UDP port number used by the authentication server to authenticate.
6. **Accounting Port:** The UDP port number used by the authentication server to retrieve accounting information.
7. Press **Ctrl+A** go back action menu line.
8. Press <Save> to save configure value.

4.3.6.3. 802.1x PerPort Configuration

```
Intelligent Switch : 802.1x Port Status
=====

(Force Unauth=Fu, Force Auth=Fa, Auto=Au, None=No)

Port          Status
-----
PORT4         No
PORT5         No
PORT6         No
PORT7         No
PORT8         No
PORT9         Au
PORT10        Au
PORT11        No

actions->    <Quit>    <Edit>    <Save>    <Previous Page>    <Next Page>
Select the Action menu.
Arrow/TAB/BKSPC = Move Item  Quit = Previous menu  Enter = Select Item
```

In this page, set the authorization status to activate 802.1x function by port

1. Select <Edit>.
2. **Status:** Press <Space> key to choose Fu / Fa / Au / No authorization status.
3. Press **Ctrl+A** go back action menu line.
4. Select <Save> to save all configure value.

Note:

Fu : Force the specific port to be unauthorized.

Fa : Force the specific port to be authorized.

Au : The state of the specific port was determined by the outcome of the authentication.

No : The specific port didn't support 802.1x function.

4.3.6.4. 802.1x Misc Configuration

```
Intelligent Switch : 802.1x Misc Configuration
=====

Quiet-period <0..65535,default=60>      : 60
Tx-period <0..65535,default=30>          : 30
Supplicant-timeout <1..300,default=30>   : 30
Server-timeout <1..300,default=30>       : 30
ReAuthMax <1..10,default=2>              : 2
Reauth-period <1..9999999,default=3600> : 3600

actions->      <Edit>          <Save>          <Quit>
Select the action menu.
Arrow/TAB/BKSPC = Move Item  Quit = Previous menu  Enter = Select Item
```

1. Press <Edit>.
2. **Quiet Period** : Used to define periods of time during which it will not attempt to acquire a supplicant (Default time is 60 seconds).
3. **Tx Period** : Used to determine when an EAPOL PDU is to be transmitted (Default value is 30 seconds).
4. **Supplicant Timeout** : Used to determine timeout conditions in the exchanges between the supplicant and authentication server (Default value is 30 seconds).
5. **Server Timeout** : Used to determine timeout conditions in the exchanges between the authenticator and authentication server (Default value is 30 seconds).
6. **ReAuthMax** : Used to determine the number of re-authentication attempts that are permitted before the specific port becomes unauthorized (Default value is 2 times).
7. **Reauth Period** : Used to determine a nonzero number of seconds between periodic re-authentication of the supplications (Default value is 3600 seconds).
8. Press **Ctrl+A** go back action menu line.
9. Press <Save> to save configures value.

4.4. Status and Counters

```

Intelligent Switch : Status and Counters
=====

Port Status
Port Counters
System Information
Main Menu

Display current status of all the switch ports.
Arrow/TAB/BKSPC = Move Item      Enter = Select Item

```

You can press the key of **Tab** or **Backspace** to choose item, and press **Enter** key to select item.

4.4.1. Port Status

This page display every port status

```

Intelligent Switch : Port Status
=====

Port      Link Status  InRate  OutRate  Enable  Auto  Spd/Dpx  Flow Control
-----
PORT4    Up           0        0        Yes     AUTO  100 Full  On
PORT5    Down        0        0        Yes     AUTO  10 Half  Off
PORT6    Up           0        0        Yes     AUTO  100 Full  Off
PORT7    Down        0        0        Yes     AUTO  10 Half  Off
PORT8    Down        0        0        Yes     AUTO  10 Half  Off
PORT9    Down        0        0        Yes     AUTO  10 Half  Off
PORT10   Down        0        0        Yes     AUTO  10 Half  Off
PORT11   Down        0        0        Yes     AUTO  10 Half  Off

actions->  <Quit>      <Previous Page>  <Next Page>
Select the action menu.
Arrow/TAB/BKSPC = Move Item  Quit = Previous menu  Enter = Select Item

```

Link Status: Display the port is link or no link.

InRate: Display the input rate control (100K/unit) setting value.

OutRate: Display the output rate control (100K/unit) setting value.

Enabled: Display the port is enabled or disable depended on user setting. Enable will be display “Yes”, disable will be display “No”. If the port is unlink will be treated as “No”.

Auto: Display the port is link on which Nway mode: Auto, Nway_Force, and Force.

Spd/Dpx: Display the port speed and duplex.

FlowCtrl: In auto / Nway force mode, display the flow control status is enable or not after negotiation.

In force mode, display the flow control status is enabling or disable depending on user setting.

Actions->

<Quit>: Exit the page of port status, and return to previous menu.

<Previous Page>: Display previous page.

<Next page>: Display next page.

4.4.2. Port Counters

The following information provides a view of the current status of the unit.

Intelligent Switch : Port Counters							
Port	TxGoodPkt	TxBadPkt	RxGoodPkt	RxBadPkt	TxAbort	Collision	DropPkt
PORT4	8035	0	44738	0	0	0	89
PORT5	0	0	0	0	0	0	0
PORT6	43595	0	6943	0	0	0	3
PORT7	0	0	0	0	0	0	0
PORT8	0	0	0	0	0	0	0
PORT9	0	0	0	0	0	0	0
PORT10	0	0	0	0	0	0	0
PORT11	0	0	0	0	0	0	0

actions-> <Quit> <Reset All> <Previous Page> <Next Page>
Configure the action menu.
Arrow/TAB/BKSPC = Move Item Quit = Previous menu Enter = Select Item

Actions->

<Quit>: Exit the page of port status, and return to previous menu.

<Reset All>: Set all count to 0.

<Previous Page>: Display previous page.

<Next page>: Display next page.

4.4.3. System Information

MAC Address: The unique hardware address assigned by manufacturer.

Firmware Version: Display the switch's firmware version.

ASIC Version: Display the switch's Hardware version.

Module 1 Type: Display the module 1 Type: 1000Tx or 100Fx ext. Depend on module card mode.

Module 1 information: Display the information saved in EEPROM of module1.

Module 2 Type: Display the module 2 Type: 1000Tx or 100Fx ext. Depend on module card mode.

Module 2 information: Display the information saved in EEPROM of module2.

```
Intelligent Switch : System Information
=====

MAC Address          : 000A17550526

Firmware version     : 10.03.01

ASIC version         : A7.00

Module 1 Type        : NC
Module 1 information  : N/A
Module 2 Type        : NC
Module 2 information  : N/A

actions->           <Quit>
Display the switch system.
Arrow/TAB/BKSPC = Move Item   Quit = Previous menu   Enter = Select Item
```

4.5. Reboot Switch

```
Intelligent Switch : Restart Configuration
=====

Default
Restart
Previous Menu

Recovering to default.
Arrow/TAB/BKSPC = Move Item   Enter = Select Item
```

4.5.1. Default

Reset switch to default configuration, default value please *section 2-4-14*.

```
Resetting to the default will restart the system automatically!
Do you want to continue? (y/n)
```

4.5.2. Restart

Reboot the switch in software reset.

4.6. TFTP Update Firmware

This page provide user to update firmware or restore EEPROM value or upload current EEPROM value.

```
Intelligent Switch : TFTP Update firmware Configuration
=====

TFTP Update Firmware
TFTP Restore configuration
TFTP Backup configuration
Previous Menu

Use TFTP to update firmware.
Arrow/TAB/BKSPC = Move Item      Enter = Select Item
```

4.6.1. TFTP Update Firmware

This page provides user use TFTP to update firmware.

```
Intelligent Switch : TFTP Update Firmware
=====

TFTP Server      : 192.168.223.99
Remote File Name : image.bin

actions->      <Edit>          <Save>          <Quit>
Select the action menu.
Arrow/TAB/BKSPC = Move Item      Quit = Previous menu      Enter = Select Item
```

Actions->

1. Start the TFTP server, and copy firmware update version image file to TFTP server.
2. Press <Edit> on this page.
3. **TFTP Server:** Type the IP of TFTP server.
4. **Remote File Name:** Type the image file name.
5. Press **Ctrl+A** go to action line.
6. Press <Save> key, it will start to download the image file.
7. When save successfully, the image file download finished too.
8. Restart switch.

4.6.2. Restore Configure File

This page user can restore EEPROM value, save image file before, form TFTP server.

```
Intelligent Switch : Restore Configuration File
=====

TFTP Server      : 192.168.223.99
Remote File Name : data.dat

actions->      <Edit>          <Save>          <Quit>
Select the action menu.
Arrow/TAB/BKSPC = Move Item  Quit = Previous menu  Enter = Select Item
```

Actions->

1. Start the TFTP server.
2. Press <Edit> on this page.
3. **TFTP Server:** Type the IP of TFTP server.
4. **Remote File Name:** Type the image file name.
5. Press **Ctrl+A** go to action line.
6. Press <Save> key, it will start to download the image file.
7. When save successfully, the image file download finished too.
8. Restart switch.

4.6.3. Backup Configure File

This page user can save current EEPROM value to image file. Then go to the update configure page to restore the EEPROM value.

```
Intelligent Switch : Backup Configuration File
=====
|
TFTP Server       : 192.168.223.99
Remote File Name  : data.dat

actions->         <Edit>           <Save>           <Quit>
                  Select the action menu.
Arrow/TAB/BKSPC = Move Item  Quit = Previous menu  Enter = Select Item
```

Actions->

1. Start the TFTP server.
2. Press <Edit> on this page.
3. **TFTP Server:** Type the IP of TFTP server.
4. **Remote File Name:** Type the image file name.
5. Press **Ctrl+A** go to action line.
6. Press <Save> key, it will start to upload the image file.
7. When save successfully, the image file upload finished too.
8. Restart switch.

5. Application Examples

5.1. VLAN application used with switch

VLAN is a simple solution to protect your network against broadcast storming by creating segments based on Layer2 Ethernet information and avoiding the complexity and the heavy processing requirements of Layer3 IP based routers.

As a result, each group of stations connected to separate Segmented Ports forms different isolated Broadcast Domain. The Broadcast Sharing Ports should be used to connect servers and other common services, such as Internet access, that are used by all the stations connected to the different Segmented Ports.

Virtual LAN, or VLAN, is generally defined as broadcast domain. It can be viewed as a group of end nodes, possibly on different physical network segments, which can communicate with each other.

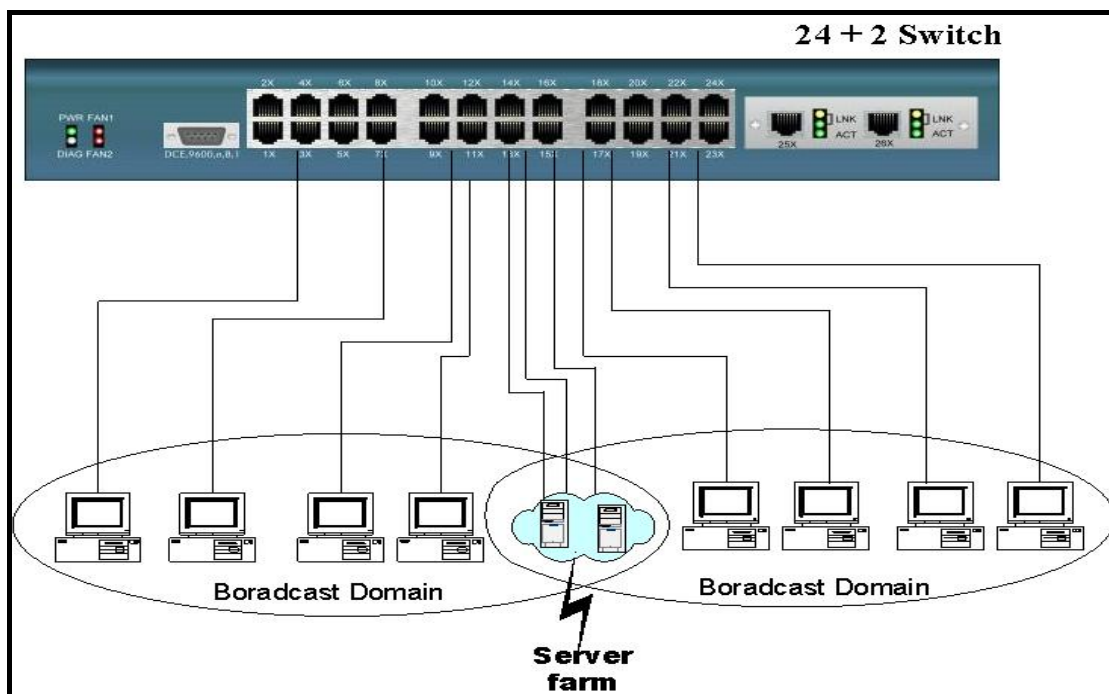

Benefits of VLANs

- Grouping users into logical networks for performance enhancement.
- Provides effective broadcasts containment between Segmented Ports, which prevents flooding of a network.
- Offers security by completely isolating from each other the different Broadcast Domains connected on separate Segmented Ports.
- Preserving current investment in equipment and cabling.
- Providing an easy, flexible, economic way to modify logical groups when needed.
- Network administrators can easily "fine tune" the network.
- Keeping network structure from the physical topology of the cabling.
- Making large networks more manageable.

You can group users according to some shared characteristic, such as a common business function or a common protocol. A single switch may have several independent VLANs within it. Below is a example that R&D, Manufacturing and Administration group can be partitioned into two different VLAN group, even members in different group can't talk directly, but they still share the same server, such as MRP server, printer server in Administration group...etc.

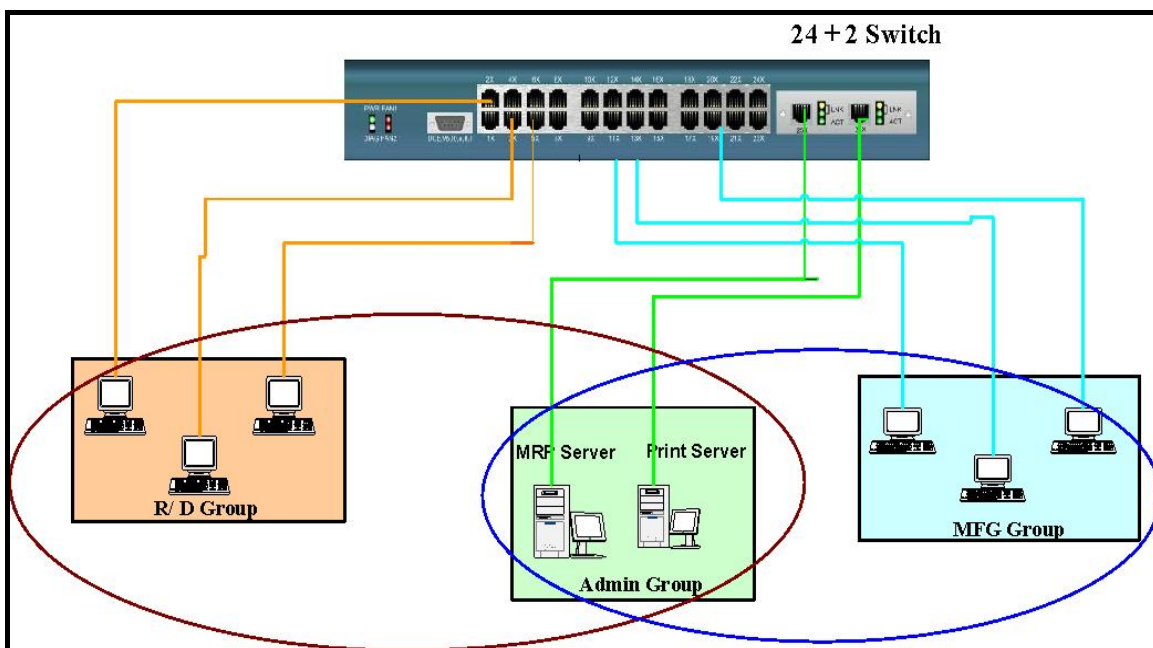

5.2. Trunking Application used with switch

Trunking allows you to increase the available bandwidth between switches by grouping ports into a trunk. Trunk can also be used to connect server to switches for higher bandwidth service required. You can use trunking to improve the throughput between segments. Moreover, this switch furtherly provides trunk with fail-over function, that is, when one of the links of trunk is fail or broken, the traffic originally go through that link will be automatically re-direct to other links of trunk, this give the trunk with redundancy and greatly increase the value of trunking.

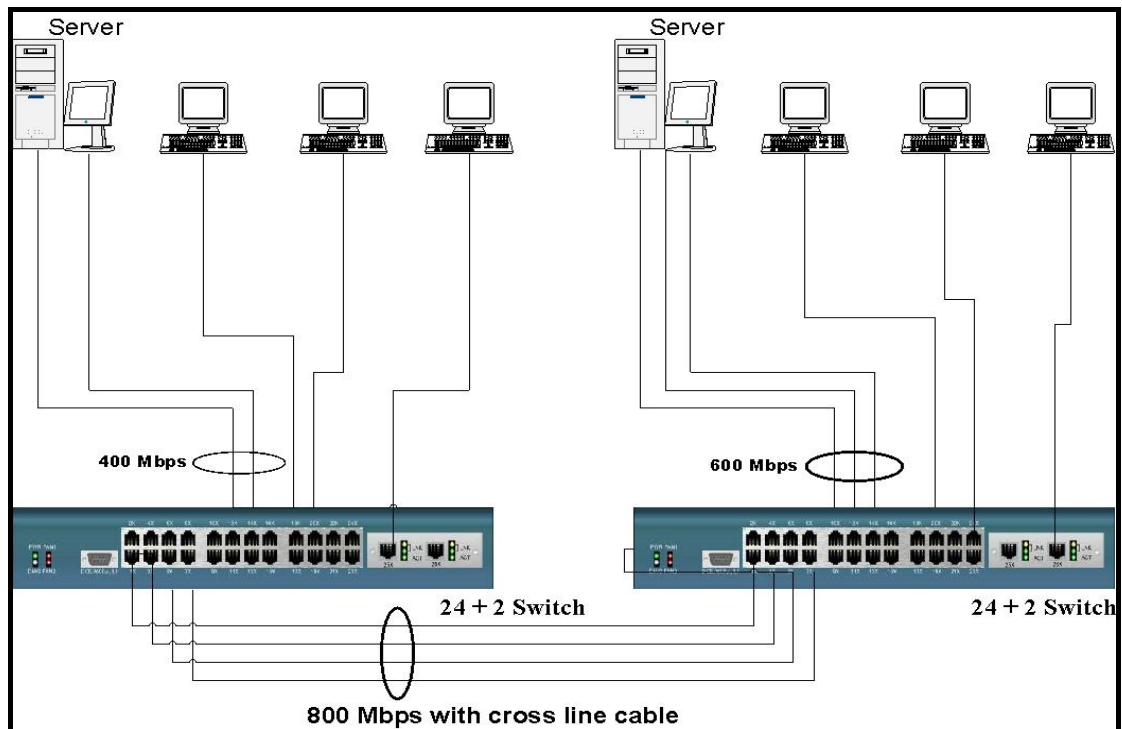

5.3. “Single IP – Agent mode” application

Single IP is a management utility of network devices for administrator to access private IP devices through a single IP (real IP or private IP). By this utility, administrator can manage much more network devices than ever and reduce the demand of real IPs, because every real IP switch can be an agent host for any network devices in their private IP domain. The Single-IP feature is able to manage up to 32 devices in the LAN using one IP address.

There are some defects in the current solutions of network management. For example, switches with legacy “stack” capability have to stack together due to their special limited-length cables, and have the limitation of stacking quantities and brand compatibility due to hardware specification. Moreover, administrator always has troubles in finding out the target window among those multi-display interfaces. Though there are expert network management utilities available in the current market, like HP OpenView, expensive cost and difficult task of implementation into embedded system are main drawbacks for their practical application.

Because of the rapid development of Ethernet, the scare of real IP shortage becomes a serious issue when an enterprise continues its IA growth. It is a resource waste and cost a large expense that every individual host has its own real IP inside the enterprise’s network. Privates IPs and NAT function (provided by router, gateway or IP sharing) provide a solution to the shortage of real IP, but new issue gives rise to that remote user from Internet has no access permission into the private IP domain, thus an administrator has no choose but accesses the private IP devices from the very location of the local area network to trouble shoot any problems that network clients report, until now “Single IP-Agent mode”, one of this switch special features, provides a new solution for all issues above.

There are benefits of “Single IP-Agent mode”:

1. Reduce the demand of real IP (public IP).

Since there are up to 32 devices which have a IP agent as “Single IP” switch, meaning that the switch becomes a network agent and handles all functions of these devices, MIS can reduce the number of hosts that are directly connected to Internet, and make use the saved real IPs more efficiency.

2. Integrate network devices without modifying hardware or software.

“Single IP” is a technique mainly based on application layer in OSI standard. The connection between master and slave hosts is linked by Ethernet protocol. It is little concern of hardware and packet transmits. Modifications of hardware or software of the slave hosts are not necessary. Thanks to the characteristics, single IP switch gives the best compatibility with other network devices, router, gateway, web server and even another brand switch.

3. Handy User interface without learning complex setting or changing user’s habit of

operation.

A floating menu gives a comprehensive user interface for administrator to pick the managed devices. It provides host IP and host name in the same time, saving the trouble that the administrator tries to remember which IPs those slave hosts are assigned to. Since there is only one browser window displaying on the screen at one time, Agent Manager plays a role like a TV channel Remote Controller. Administrator can easily switch to the device he/she wants and enter the configuration webpage as desired.

4. Totally remote control of network devices in private IP domain.

It is not necessary for MIS to put all devices together in one place. Single IP function will operate normally no matter how far the distance is between the master and the slave hosts if their packets can reach each other in local area network. Moreover, a remote administrator can access the far-side servers in the private domain through the intermediary of single IP switch which is directly connected to Internet.

5. No up-link limitation through Gigabit port.

Unlike stacking mode, up-link in agent mode can be achieved through any port rather than Gigabit port only. This provides great flexibility as long as network administrator can access them, and hence Gigabit ports can be saved for other applications.

5.3.1 Typical setup of “Single IP-Agent mode” network:

The basic rules to set up “Single IP”:

1. The “Agent IP” of master switch should be within the IP domain of the managed hosts. (slave switches)
2. The “Agent IP” should be the same as “Switch IP” if administrator is within the IP domain of slaves; In other hand, the “Agent IP” should be different from “Switch IP” if administrator want to manage the slaves cross IP domain.

There are three typical examples to demonstrate the usage of “Single IP-Agent mode”.

1. Master and slave switches in the same LAN domain.

In this example, master switch will manage 2 slave switches and 1 router.

Switch IP of master is 192.168.223.100. Set its management mode to “Agent Master”.

Since the IP domain of slaves and router are in the IP domain 192.168.223.0, Agent IP of master should be set as same as switch IP (192.168.223.100).

Add slave1 and slave2 into agent list by auto-discover or by manual. Router can only be added by manual. Administrator (192.168.223.30) can access those slaves through master.

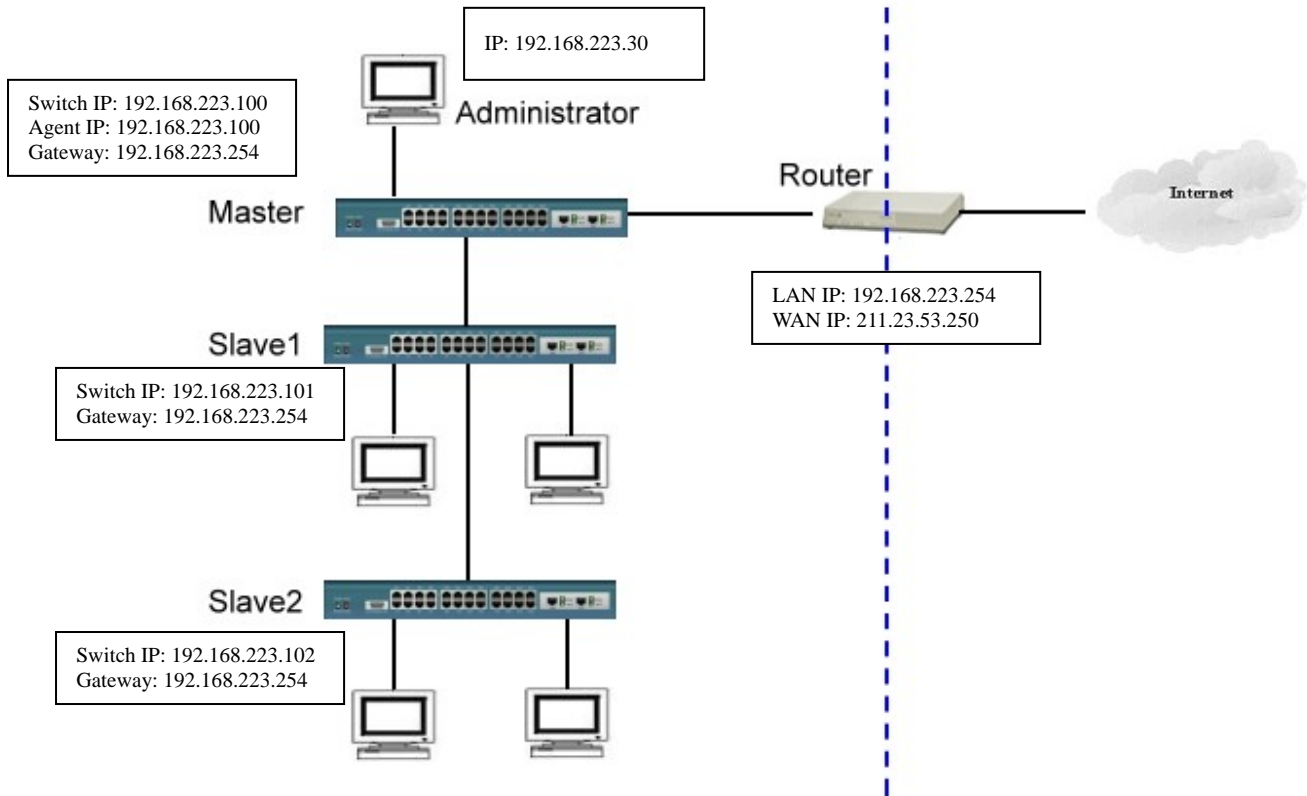

2. Master and slave switches in different LAN domain.

In this example, master will manage 2 slave switches and 1 router in other IP domain.

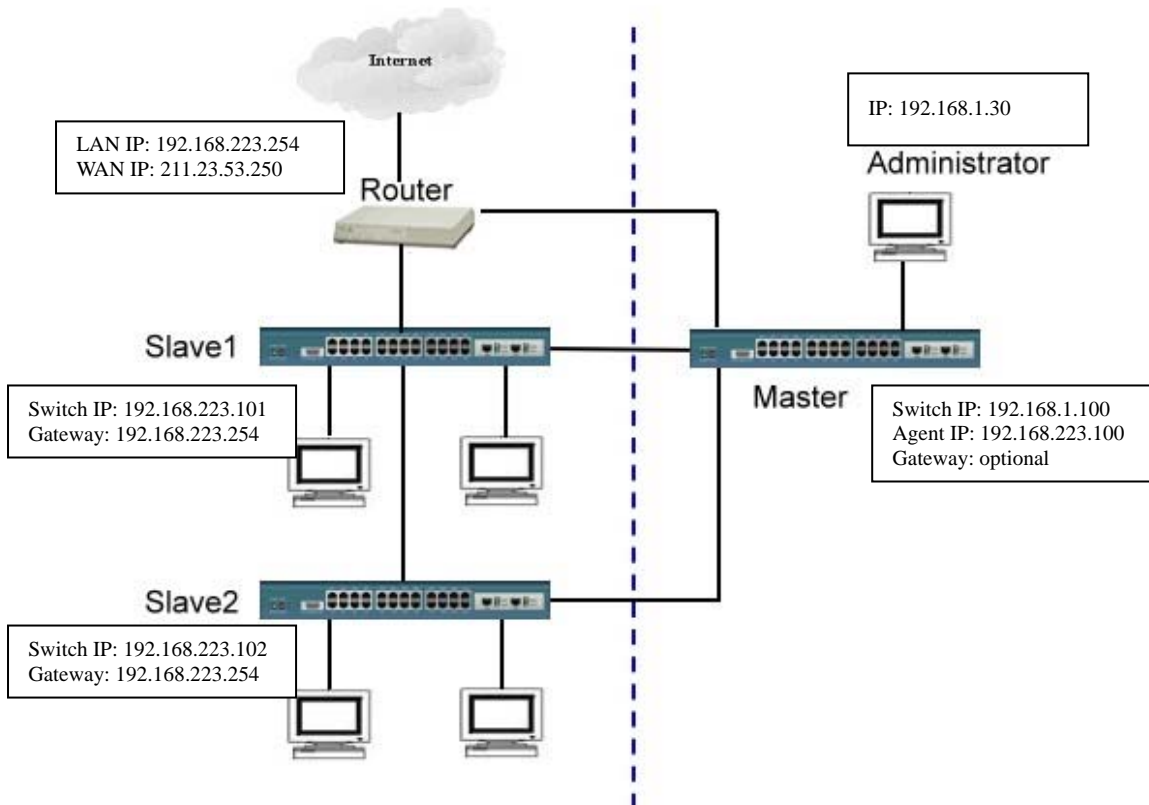

The differences from example1 are that administrator and master switch IP are in the other IP domain (192.168.1.0).

Switch IP of master is 192.168.1.100. Set its management mode to “Agent Master”.

According to the basic rule 1, agent IP should be set in the same domain of slaves, that is, 192.168.223.100. The other procedures are the same as example 1.

Now administrator (192.168.1.30) can access the slaves in other domain (192.168.223.0).

3. Master in WAN domain and slaves in LAN domain.

This example gives the practice application for remote management.

The differences from example 2 are that master switch links directly to Internet and administrator from worldwide can access it through Internet.

Set the Switch IP and gateway of master switch to real IP (211.23.53.251 and 211.23.53.249) and make sure administrator can access the master switch from Internet. The other procedures are the same as example 1.

Now administrator from Internet can access the slaves in other domain (192.168.223.0).

Somewhat we can image the master is playing a role of tiny virtual server for these slaves.

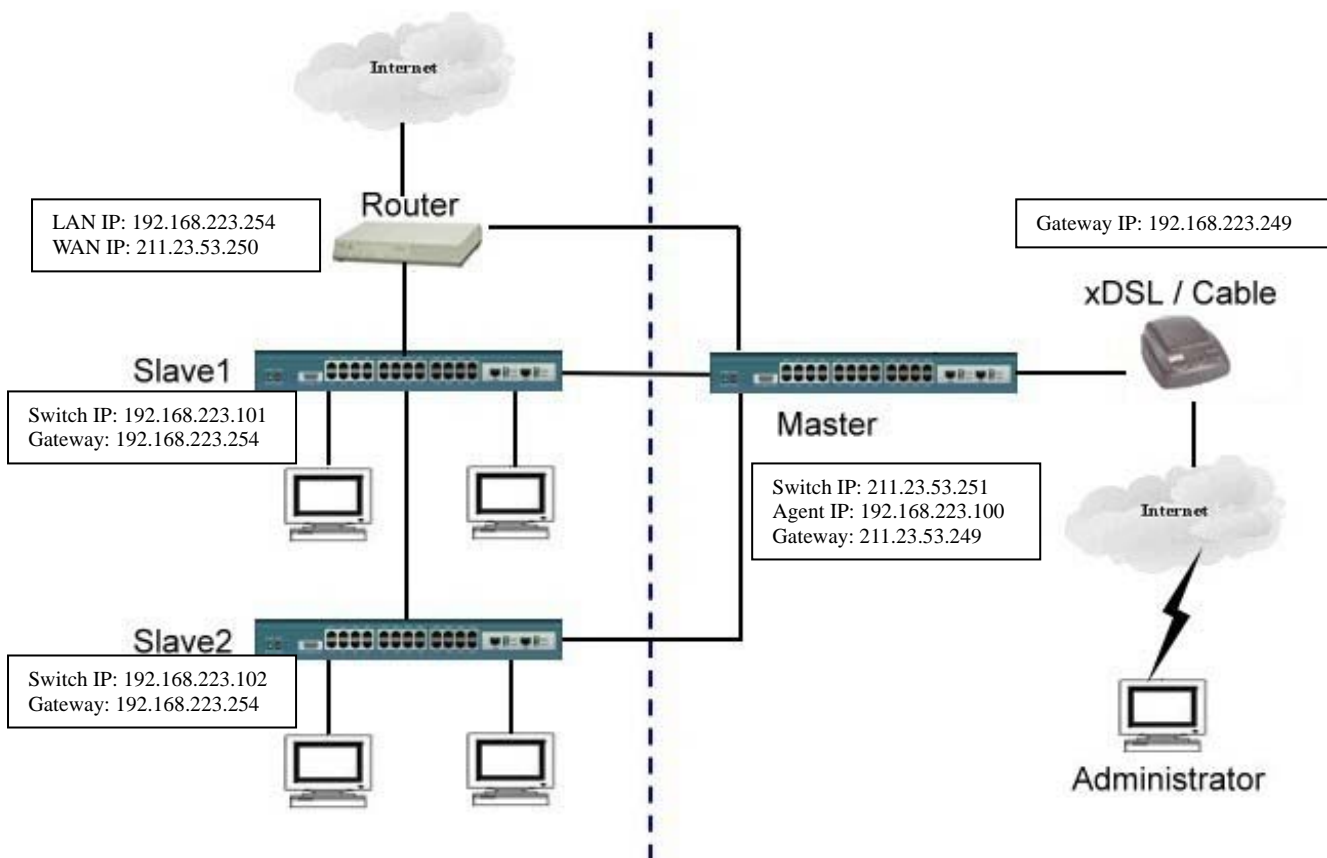

5.4. “Single IP - Stacking mode” application with Switch

This switch provides traditional stacking mode to stack with maximum 32 switches by cascading their Gigabit ports (purchased separately). **For better performance, we recommend stacking no more than 8 Switches.** This feature helps network administrator to easily use one switch assigned as the master to manage the other stacked switches through the browser. That is, the master can bring a “global view” showing all stacked devices to network administrator as long as he/she accessed to the master switch by using its IP (this IP should be public for remote access through the Internet). This will easily let the network administrator know the group settings (e.g. tag-based VLAN groups) and link status among all stacked units. A typical arrangement of network connection of “Single IP – Stacking mode” is shown below:

Typical connections for switch management by stacking

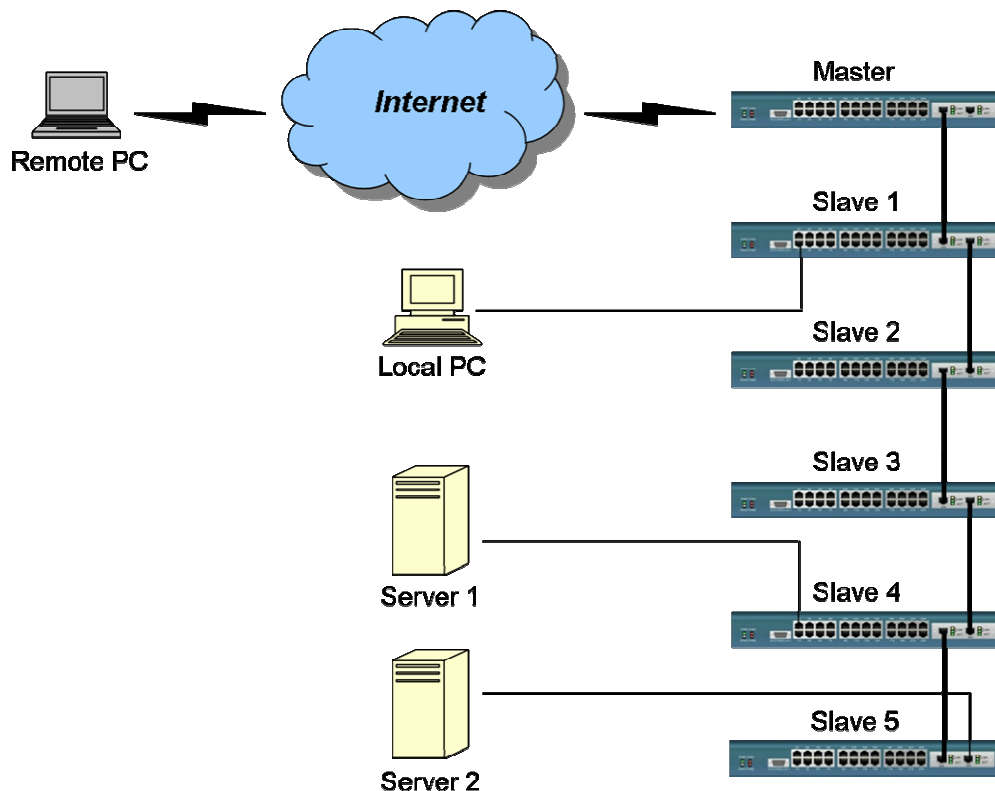

The significant characteristics of this switch are:

1. No redundant hardware required:

Unlike special requirement of connecting cable among “hardware stacking” switches, this switch provides the least demand as a Gigabit module to build up a stacking set. The Gigabit module give the best performance for inter-communication between stacking switches and the administrator can spare one port of Gigabit module in the top switch or the bottom one in

the stack for flexible usage.

2. Well integrated UI to view status of stacking switches:

An user-friendly Web UI provides user to have a total view of the port link status and VLAN group settings for all stacked switches *at a glance*.

3. Easy adding or removal stacking member:

All Stacking members can be easily added or removed through the network. By clicking on the UI, the administrator can quickly determinate which switch will join the stack, without adjusting the network connection in front of those switches. It saves great efforts when trouble-shooting the network abnormality.

5.4.1 A guide to build up “Stacking Switches”

Follow these steps to build up a set of “Stacking Switches”:

1. Connect switches with Giga port (purchased separately) in serial sequence.

By reference to the picture of typical network connection of “Single IP – Stacking mode”, user can connect these stacking switches with Giga port in serial sequence. **Technically, in “Stacking Mode”, the Master Switch is able to connect/control up to 31 Slave Switches (total 32 Switches); however, for better performance, we recommend stacking no more than 8 Switches.**

A connection check by pinging these switches’ IP will help to avoid network failure.

2. Make sure the master switch is set to “Stacking Master” and slaves to “Stacking Slave”.

In the Main Menu in “Administrator/IP & Management Mode”, user has to set the management mode to “Stacking Master” and slave switches to “Stacking Slave”.

User who wishes to access the stacking switches from remote IP, should fill up the switch IP with its real IP and the agent IP with the alternative LAN IP; on the other hand, for a local area network access only, the switch IP and agent IP should be kept as the same as the LAN IP.

3. Add stacking members in the Stacking management.

Please refer section 2-4-14 for detailed configuration.

4. Launch the Stack manager.

5.4.2 An Example of Port-Based Stacking VLAN

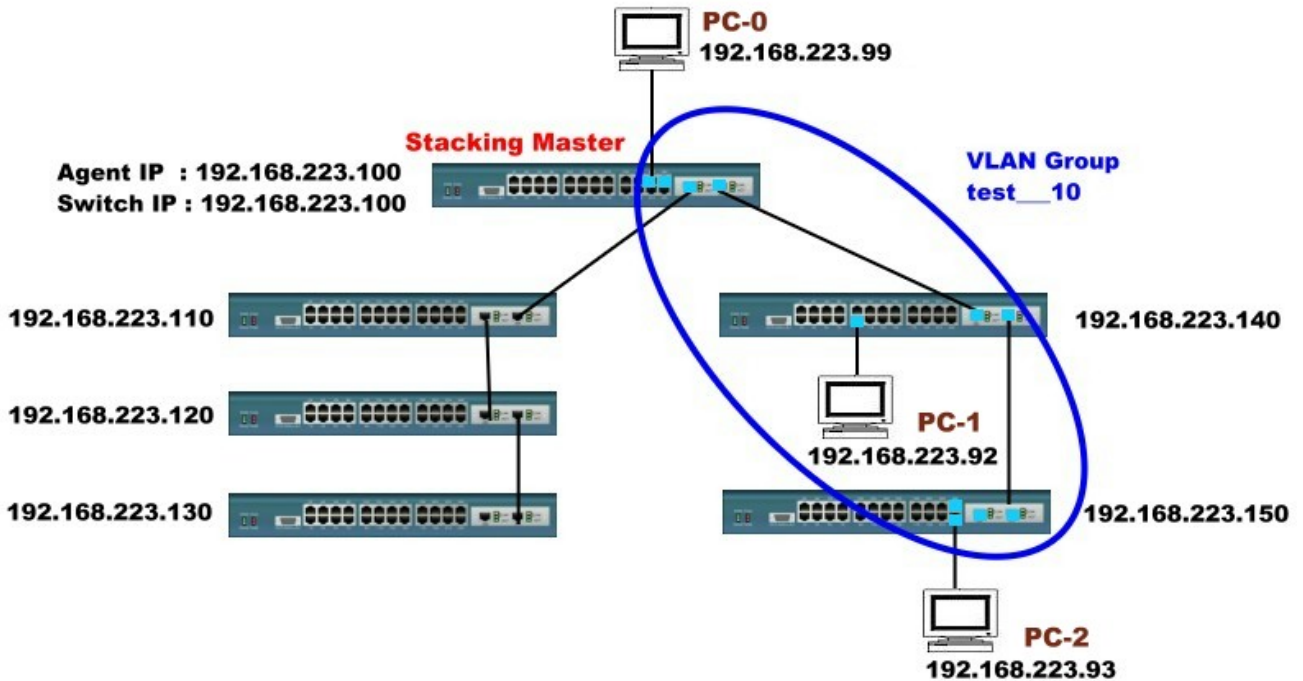

Port-Based Stacking VLAN setting:

Switch: Master (192.168.223.100)

Slaves (192.168.223.110, 192.168.223.120, 192.168.223.130, 192.168.223.140, 192.168.223.150)

PC: PC-0(192.168.223.99) on port 22 of Master (192.168.223.100)

PC-1(192.168.223.92) on port 9 of Slave 4(192.168.223.140)

PC-2(192.168.223.93) on port 23 of Slave 5(192.168.223.150)

Port-Based VLAN Group:

VLAN name : test

VLAN ID : 10

Members: Port 22, 24 of Master (192.168.223.100)

Port 9 of Slave4 (192.168.223.140)

Port 23, 24 of Slave5 (192.168.223.150)

Test case:

1. PC-0 ping or trace PC-01 and PC-02 (The same VLAN)
2. Remove port 9 of Slave4 from VLAN test, and process test1 again.

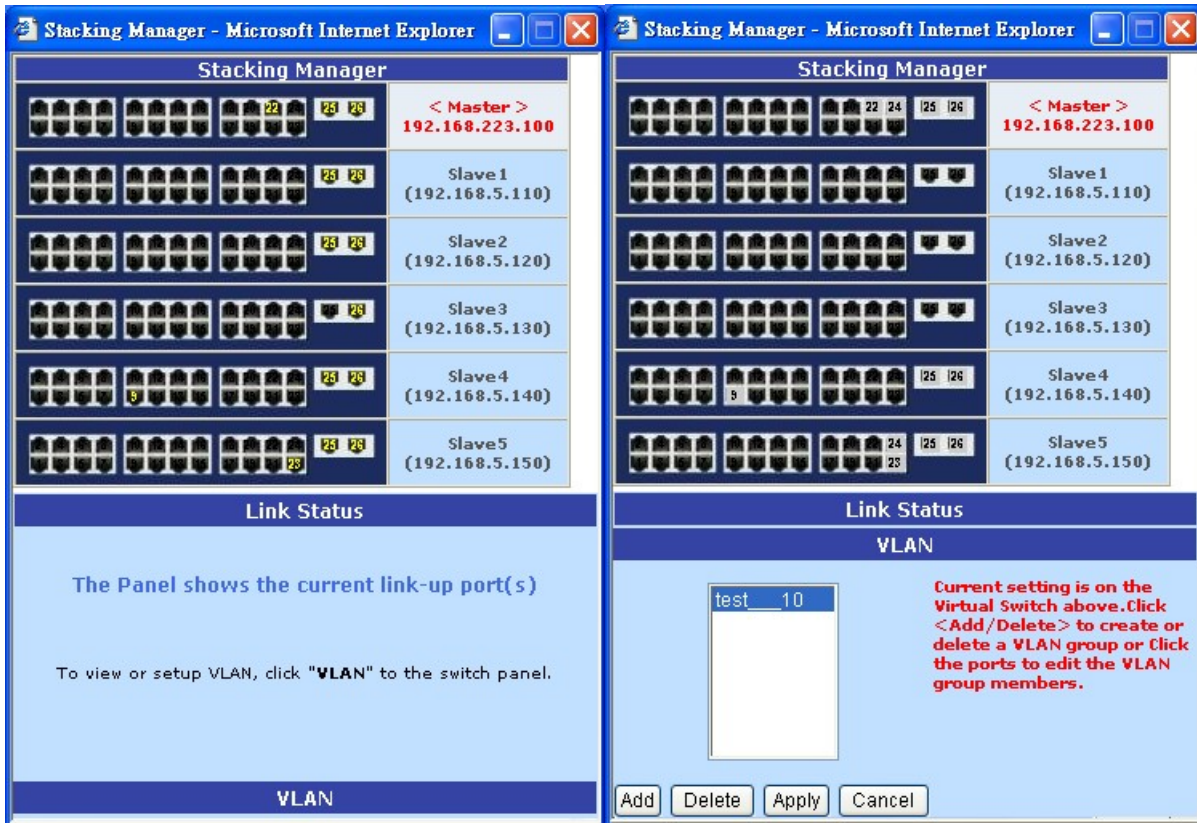

Result:

1. PC-0 can access both PC-01 and PC-02.

```
C:\Documents and Settings\Administrator>tracert 192.168.223.92
Tracing route to 192.168.223.92 over a maximum of 30 hops
 1    <1 ms    <1 ms    <1 ms    192.168.223.92
```

```
C:\Documents and Settings\Administrator>tracert 192.168.223.93
Tracing route to 192.168.223.93 over a maximum of 30 hops
 1    <1 ms    <1 ms    <1 ms    192.168.223.93
```

2. PC-0 can only access PC-02 only. PC-01 will not reply.

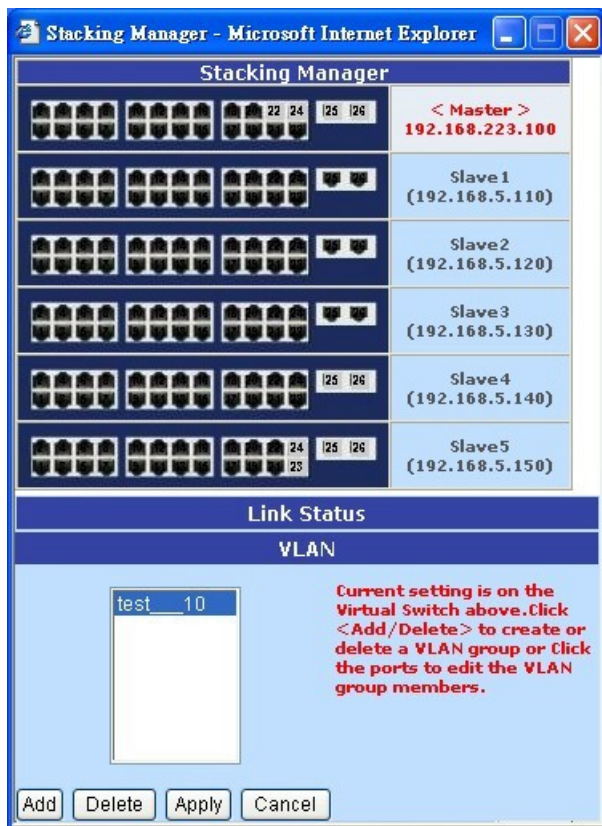

```
C:\Documents and Settings\Administrator>tracert 192.168.223.92

Tracing route to 192.168.223.92 over a maximum of 30 hops

 1  *      *      *      Request timed out.
 2  *      *      *      Request timed out.
 3  *      *      *      Request timed out.
```

```
C:\Documents and Settings\Administrator>tracert 192.168.223.93

Tracing route to 192.168.223.93 over a maximum of 30 hops

 1  <1 ms  <1 ms  <1 ms  192.168.223.93
```

5.4.3 Limitation with Trunking in Stacking mode

Two basic rules declare here:

1. Stacking members can't and trunk with each other.
2. Stacking members can trunk with non-stacking member.

The packet traffics between stacking members are transferred only through Giga module. Trunking between stacking members may cause the spanning tree protocol (STP) to alter the topology and change the routed ports. If it happens, Giga port traffic may break and the stacking mechanism will fail.

For non-stacking member, it has no such limitation.

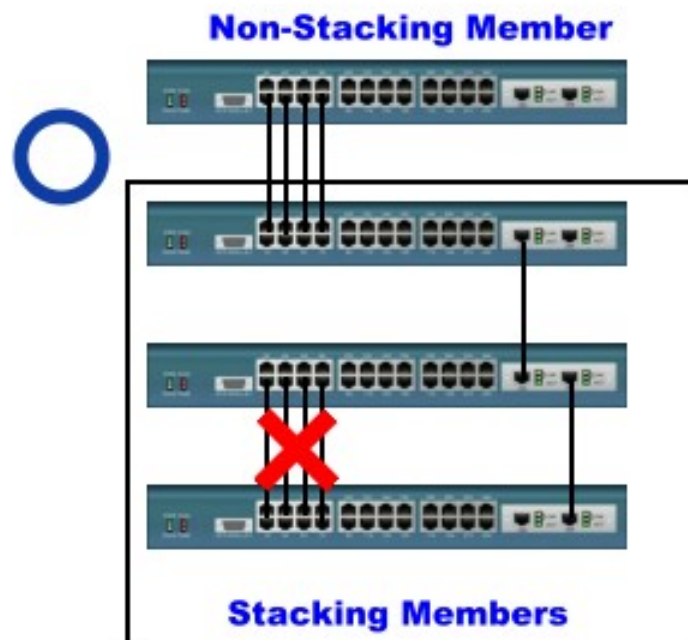

5.5 Compatibility on Virtual Server and “Single IP”

There are practical applications on combination of virtual server and single IP. Network administrator prefers a router as unique gateway to Internet while he/she likes to use the “Single IP” to manage his network hosts both from LAN and WAN. This example gives a guide how to setup virtual server with agent/stacking switch.

Example target:

1. Any client with port 80 (http) go to company’s default web server (example 192.168.223.80)
2. Any client with port 28010 go to agent/stacking switch.(example 192.168.223.90).
3. Any client can use the agent/stacking function through virtual server.

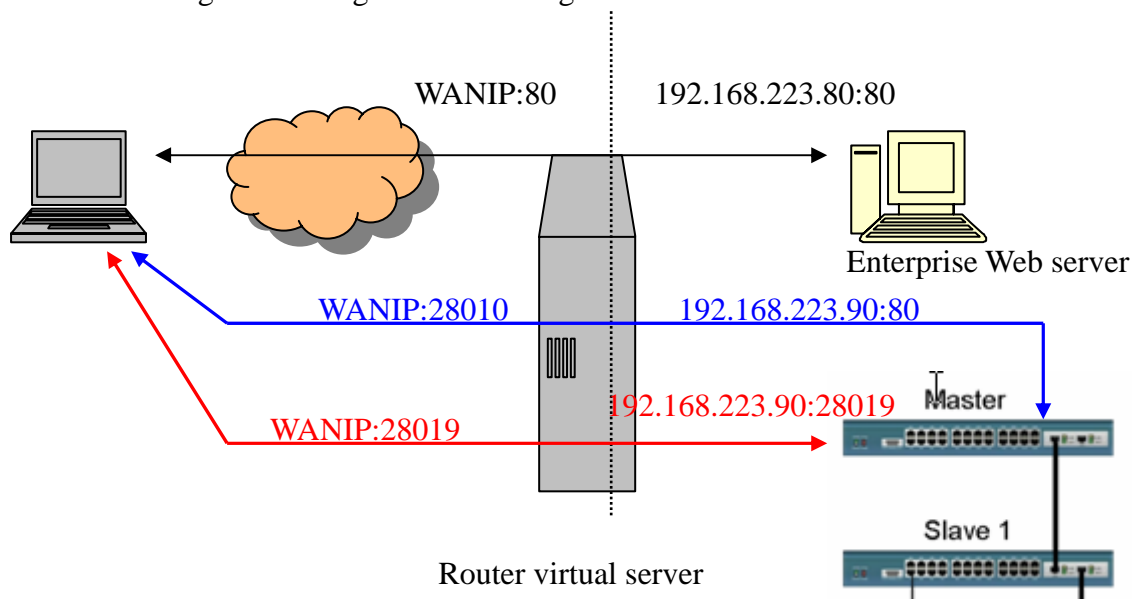

The instructive pictures may vary depending on the router the user sets up. The sample uses a GR102 router module for demonstration.

Step 1: Set up web server mapping port (211.23.53.252:80 → 192.168.223.80:80)

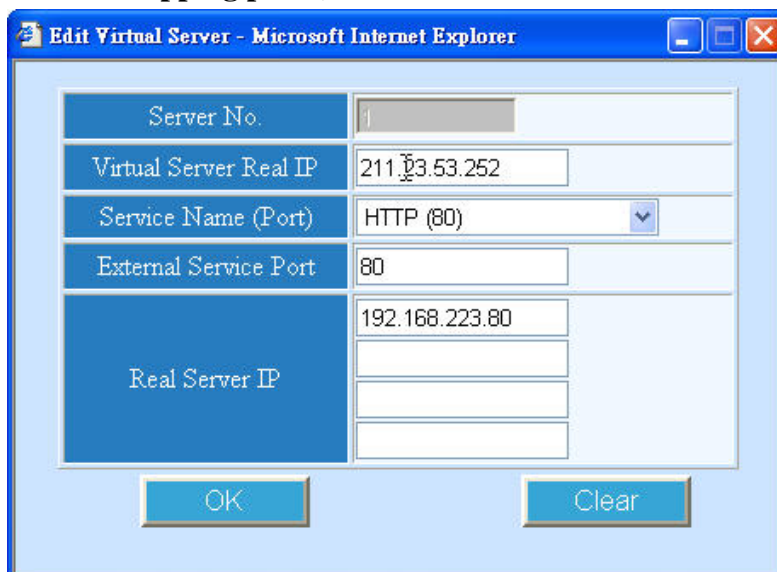

Step 2. Set up agent/stacking switch mapping port (211.23.53.252:28010->192.168.223.90:80)
(Note: Some Routers are not able to allow users to direct External Service Port (28010) to Local Service Port (80). In that case, user must have Port 80 available for the Switch.)

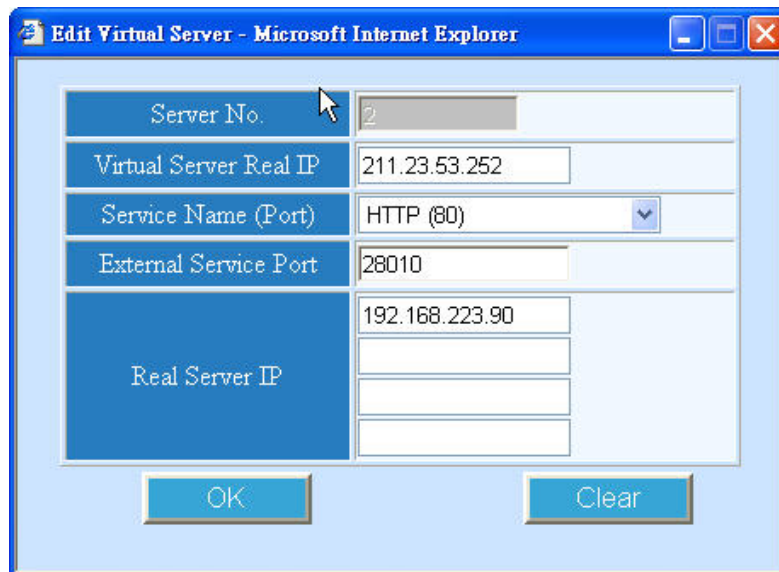

Step 3: Set up agent function mapping port (211.23.53.252:28019->192.168.223.90:28019)

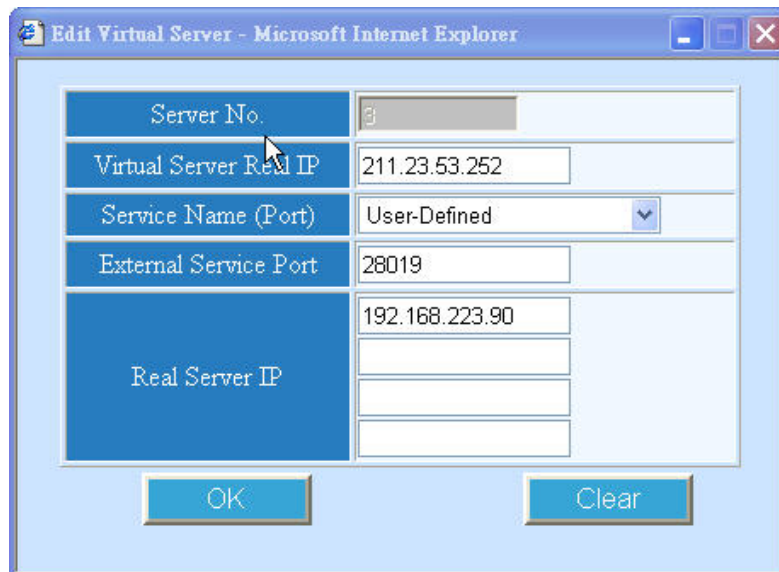

Step 4: Modify Master’s “Agent IP” to new IP other than its “Switch IP” (Important)

According to the basic rule 2 of “Single IP”, if administrator would like to access the slaves from Internet and master’s Switch IP should differ from its Agent IP.

In this case, change Agent IP to 192.168.223.91 to meet the rule, even though Switch IP and Agent IP are still within the same IP domain.

Note: If administrator wishes to access the slaves from LAN , he/she should change back the

Agent IP to Switch IP again before launching the Agent/Stacking Manager..

DHCP:

Switch IP Address	192.168.223.90
Switch Subnet_Mask	255.255.255.0
Switch Gateway	192.168.223.254

Management Mode :
(Default : Agent Slave)

Agent IP Address	192.168.223.91
Agent Subnet_Mask	255.255.255.0

TRENDware Technical Support:
3135 Kashiwa Street
Torrance, CA 90505
Tel: +1-310-891-1100
Fax: +1-310-891-1111
E-mail: support@trendware.com
www.trendnet.com